



Frigoduman[®]



Price List - 2024

- Prices in the list are excluding tax.
- Store delivery prices. Transportation and insurance belongs to the buyer.
- Any changes in taxes and funds will be reflected in our prices.
- Our company has the right to change prices without prior notice.

BANK ACCOUNT NUMBERS

İZMİR		
Name of Bank	Account Type	IBAN No
TÜRKİYE VAKIFLAR BANKASI T.A.O.	EURO	TR25 0001 5001 5804 8022 7944 12
	USD	TR95 0001 5001 5804 8022 5692 76
GARANTİ TOPTANCILAR	EURO	TR76 0006 2000 2690 0009 0021 30
	USD	TR04 0006 2000 2690 0009 0021 65
YAPI KREDİ	EURO	TR45 0006 7010 0000 0068 1202 54
	USD	TR91 0006 7010 0000 0068 1233 06
İŞ BANKASI	EURO	TR37 0006 4000 0023 4560 0316 11
	USD	TR75 0006 4000 0023 4560 0316 06
HALKBANK	EURO	TR80 0001 2009 4370 0058 0000 57
	USD	TR77 0001 2009 4370 0053 0003 43

CONTACT US

İZMİR
FRİGODUMAN SOĞUTMA SAN. ve TİC. A.Ş. 2818 Street No: 24 Mersinli / İZMİR Tel: +90 232 469 05 00 (Pbx) Fax: +90 232 449 78 33 e-mail: satis@frigoduman.com
İSTANBUL
FRİGODUMAN SOĞUTMA SAN. ve TİC. A.Ş. Irmak Street No: 75 Dolapdere / İSTANBUL Tel: +90 212 237 97 77 (Pbx) Fax: +90 212 237 97 37 e-mail: istanbul@frigoduman.com

**ATTENTION: The prices on our website are constantly updated.
Do not process without comparing with the prices on our website.**

Product Name	Page
FUSHENG Screw Compressors (BSR - SRT - SST)	4
MITSUBISHI - SIAM DC Inverter Scroll Compressors	8
ALFA LAVAL Plate Heat Exchangers	12
DANFOSS H Series Scroll Compressors	14
DANFOSS SZ Series Scroll Compressors	15
DANFOSS H Series Scroll Compressors - R410A	16
DANFOSS SH ve DSH Series Scroll Compressors	17
DANFOSS MLZ Series Scroll Compressors	18
DANFOSS LLZ Series Scroll Compressors	20
DANFOSS NTZ Series Hermetic Piston Compressors	21
DANFOSS MTZ Series Hermetic Piston Compressors	22
DANFOSS Commercial Compressors	24
DANFOSS B O C K Compressors	25
DANFOSS Electronic Expansion Valves	27
DANFOSS MCX Programmable Controllers	30
DANFOSS Thermostats	31
KELLER Transmitters	31
DANFOSS Prosestats, Mechanical Thermostats	33
DANFOSS Expansion Valves with Replaceable Orifice T2 /TE2	34
DANFOSS Expansion Valves with Replaceable Orifice TE5 / 12 / 20 / 55	36
DANFOSS Expansion Valves with Fixed Orifice	38
DANFOSS TUAE Series Bi-directional Expansion Valves R-410A	40
DANFOSS Heat Exchanger and Suction filters	41
DANFOSS Flare and Welded Stone Driers, Cartridge Sleeves, Bi-directional Driers	42
DANFOSS Solenoid Valves and Coils	44
DANFOSS Regulators	46

Product Name	Page
DANFOSS Sight Glasses	47
DANFOSS Ball Valves, Water Regulator Valves	48
DANFOSS Check Valves	49
DANFOSS - SAGINOMIYA 4-way Solenoid Valves, Fan Speed Control Modules	50
WENTO Axial and Plug Fans	51
CUOGHI Dehumidification and Adiabatic Humidifiers	54
SEUNGIL Hot Steam Humidifiers	56
SYSLAB Parametric Control Devices	58
MATCHWELL Electronic Pressure Switches - Fancoil Motor	61
HONGSEN Sight Glasses, Absorbers	62
HONGSEN Expansion Valves, Ball Valves	63
HONGSEN Flare and Welded Stone Driers, Cartridge Sleeves, Bi-directional Driers	64
HONGSEN Check Valves, Solenoid Valves and Coils	66
HONGSEN Service Tools	68
P&M Service Tools	70
Eckerle Drain Pumps	72
WENTO R-134A DC 12-24 V (LBP / MBP) Compressors	73
FULL GAUGE Control Devices	74
VALEO Vehicle Compressors	75
WENTO Flow Switch	75
F-Gas - Frigoil	76
Copper Fittings	77
GVN Liquid Tanks, Suction Accumulators, Oil Separators	78
DYNAFLEX Rubber Insulation Materials	82

FUSHENG CAPACITY LIST / BSR

Refrigerant Type		R404A		R134A		R407C	
Model	Evaporation	-10°C	0°C	-10°C	0°C	-10°C	0°C
	Condensation						
BSR 213	40°C	76,60	113,55	44,17	69,46	67,10	102,57
	50°C	62,82	94,50	36,69	59,81	55,27	88,28
BSR 216	40°C	97,60	144,67	56,28	88,49	85,70	131,00
	50°C	80,04	120,40	46,74	76,20	70,58	112,75
BSR 311	40°C	135,39	199,75	72,02	113,25	108,80	166,33
	50°C	102,46	154,13	59,82	97,52	89,61	143,16
BSR 314	40°C	155,93	231,14	89,89	141,34	136,60	208,82
	50°C	127,88	192,36	74,66	121,71	112,51	179,73
BSR 316	40°C	183,72	272,34	105,91	166,54	160,00	244,59
	50°C	150,67	226,65	87,97	143,41	131,78	210,52
BSR 321	40°C	196,87	291,83	114,75	180,43	171,49	262,16
	50°C	161,46	242,87	95,31	155,37	141,25	225,64
BSR 323	40°C	234,94	348,26	136,93	215,32	204,65	312,85
	50°C	192,67	289,83	113,73	185,41	168,56	269,27
BSR 324	40°C	261,65	387,86	151,90	238,85	227,02	347,04
	50°C	214,58	322,79	126,17	205,67	186,98	298,70
BSR 326	40°C	280,73	416,14	163,63	257,29	244,55	373,84
	50°C	230,23	346,33	135,91	221,56	201,42	321,77
BSR 413	40°C	338,29	501,47	199,25	313,30	298,12	455,73
	50°C	277,44	417,34	165,49	269,78	245,54	392,25
BSR 415	40°C	376,32	557,85	221,65	348,52	331,63	506,96
	50°C	308,62	464,26	184,09	300,11	273,14	436,34
BSR 421	40°C	435,63	645,76	254,99	400,95	381,80	583,65
	50°C	357,27	537,43	211,79	345,26	314,46	502,35
BSR 423	40°C	475,41	704,72	278,27	437,56	416,66	636,94
	50°C	389,88	586,50	231,12	376,78	343,17	548,22
BSR 424	40°C	533,89	791,42	314,17	494,01	470,49	719,23
	50°C	437,85	658,65	260,94	425,39	387,51	619,05
BSR 426	40°C	589,15	873,33	346,69	545,13	519,18	793,67
	50°C	483,17	726,82	287,95	469,41	427,61	683,12
BSR 427	40°C	650,35	964,05	383,48	599,17	573,11	876,11
	50°C	533,36	802,32	321,50	519,05	472,03	754,07
BSR 428	40°C	697,26	1033,59	411,14	642,40	614,46	939,32
	50°C	571,83	860,20	344,69	556,49	506,09	808,47

FUSHENG (BSR) SERIES SCREW COMPRESSORS

Model	Disp. (m ³ /h)	HP	Kw	Voltage	Discharge / Suction		Refrigerant Type	Operation Range	Price
BSR 213	140	45	38	(380 / 415) - 3 - 50 Hz	1 5/8"	2 5/8"	R22 - R134A - R407C - R404A	+15°C / -30°C	6.515,28 \$
BSR 216	172	60	46		1 5/8"	2 5/8"			7.147,44 \$
BSR 311	211	75	56		2 5/8"	3 1/8"			7.770,36 \$
BSR 314	268	90	70		2 5/8"	3 1/8"			8.040,89 \$
BSR 316	316	100	79		2 5/8"	3 1/8"			8.335,21 \$
BSR 321	335	120	87		3 1/8"	4"			9.215,74 \$
BSR 323	395	140	103		3 1/8"	4"			9.505,05 \$
BSR 324	438	150	113		3 1/8"	4"			10.267,34 \$
BSR 326	472	160	122		3 1/8"	4"			10.520,99 \$
BSR 413	555	200	145		3 1/8"	4"			11.213,59 \$
BSR 415	619	220	161		3 1/8"	4"			13.255,60 \$
BSR 421	689	240	183		4"	5"			14.755,40 \$
BSR 423	760	270	201		4"	5"			15.208,29 \$
BSR 424	841	300	221		4"	5"			15.684,88 \$
BSR 426	942	330	247		4"	5"			17.251,71 \$
BSR 427	1269	345	267		4"	5"			19.511,08 \$
BSR 428	1337	380	283	4"	5"	20.785,09 \$			

Suction and return valve, crankcase heater, suction filter, integrated check valve, flanged oil separator, oil level switch, oil sight glass, oil filter, 4 stage capacity control (100-75-50-25%) or stepless control (100..25%), Motor PTC sensor, discharge temperature sensor PTC, Oil drain valve, Economizer connection port, Liquid injection adapters, INT69 Motor controlled electric motor, IP54 class terminal, Compressor mounts.

* Please get information for BSR 5xx series standard and optional parts.



FUSHENG CAPACITY LIST / SRT

Refrigerant Type		R404A			R22		
Model	Evaporation	-60°C	-50°C	-40°C	-60°C	-50°C	-40°C
	Condensation						
SRT 218	40°C	11,24	18,71	29,21	9,81	16,55	26,13
	50°C	10,73	17,95	28,03	9,42	16,06	25,40
SRT 314	40°C	20,61	34,29	53,54	17,97	30,32	47,88
	50°C	20,13	33,59	52,46	17,24	29,41	46,52
SRT 321	40°C	30,04	49,97	78,01	26,18	44,19	69,78
	50°C	28,56	47,85	74,77	25,11	42,85	67,81
SRT 324	40°C	40,80	67,87	105,96	35,58	60,03	94,80
	50°C	38,79	64,99	101,59	34,09	58,19	92,09
SRT 413	40°C	50,28	83,66	130,62	43,85	73,99	116,84
	50°C	47,80	80,10	125,20	42,04	71,74	113,51
SRT 415	40°C	59,77	99,44	155,26	52,13	87,95	138,88
	50°C	56,83	95,20	148,81	49,97	85,26	134,93
SRT 424	40°C	80,50	134,00	209,40	70,90	119,60	188,90
	50°C	76,60	128,30	200,60	68,00	115,80	183,40

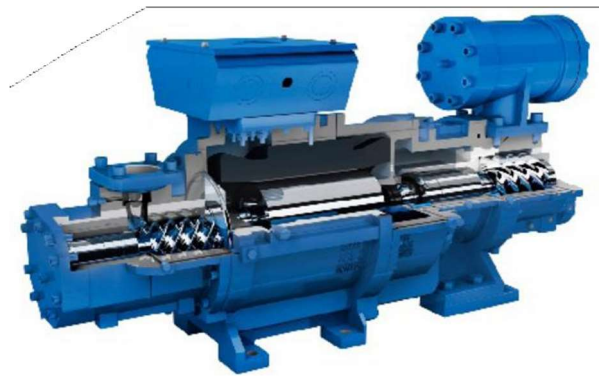

FUSHENG CAPACITY LIST / SST

Refrigerant Type		R404A			R22		
Model	Evaporation	-60°C	-50°C	-40°C	-60°C	-50°C	-40°C
	Condensation						
SST 100	40°C	9,6	16,0	24,9	8,4	14,3	22,5
	50°C	9,1	15,3	23,9	8,1	13,8	21,9
SST 140	40°C	13,4	22,4	34,9	11,8	19,9	31,5
	50°C	12,8	21,4	33,5	11,4	19,3	30,6
SST 170	40°C	16,3	27,1	42,4	14,4	24,2	38,3
	50°C	15,6	26,0	40,7	13,8	23,5	37,2

FUSHENG (SRT) SERIES DOUBLE-STAGE SCREW COMPRESSORS

Model	Disp. (m ³ /h)	HP	Voltage	Discharge / Suction		Refrigerant Type	Operation Range	Price
SRT 218	120	45	(380 / 415) -3-50Hz	1 5/8"	2 5/8"	R22 - R404A	-30°C / -65°C	11.635,34 \$
SRT 314	222	60		1 5/8"	2 5/8"			16.722,00 \$
SRT 321	320	95		2 5/8"	4"			21.221,56 \$
SRT 324	430	125		2 5/8"	4"			23.145,33 \$
SRT 413	530	150		3 1/8"	4"			27.086,00 \$
SRT 415	630	175		3 1/8"	4"			30.030,00 \$
SRT 424	730	200		3 1/8"	4"			48.592,00 \$

Discharge flange and gasket set, suction flange and gasket set, suction filter, 5 capacity control solenoids or stepless control (100..25%), motor winding PTC thermistor, discharge temperature sensor PTC, economizer injection port, liquid injection adapters, asbestos-free gasket set, integrated check valve, suction and return valve, compressor mounts, INT69 FSY motor protection control.



FUSHENG (SST) DOUBLE-STAGE SCROLL SCREW COMPRESSORS

Model	Disp. (m ³ /h)	Voltage	Discharge / Suction		Refr. Type	Operation Range	Price
SST 100	100	(380 / 415) -3-50Hz	1 5/8"	2 5/8"	R22-R404A-R507	-33°C / +55°C	10.158,80 \$
SST 140	140						12.992,80 \$
SST 170	170						15.172,80 \$



MITSUBISHI R410A DC INVERTER SCROLL 400 Volt (TANDEM COMPATIBLE)

Model	Capacity (min-max)		Cop. (60 rps)	Price
	Kw	Btu		
ANB 33FBRMT1 (20-120 rps)	3,29 Kw - 21,5 Kw	11.230 - 73.360	3,27	1.035,00 \$
ANB 42FBRMT1 (20-120 rps)	4,15 Kw - 27,3 Kw	14.160 - 93.150	3,34	1.130,00 \$
ANB 52FKEMT1 (20-120 rps)	5,45 Kw - 33,1 Kw	18.600 - 112.940	3,28	1.225,00 \$
ANB 66FKEMT1 (20-120 rps)	5,93 Kw - 34,5 Kw	23.540 - 136.800	3,31	1.320,00 \$

MITSUBISHI R410A DC INVERTER SCROLL 400 Volt (TANDEM COMPATIBLE and OIL LEVEL SENSOR)

Model	Capacity Capacity (min-max)		Cop. (60 rps)	Price
	Kw	Btu		
ANB 78FGAMT (15-120 rps)	5,75 Kw - 49,3 Kw	19.606 - 168.235	3,32	1.370,00 \$
ANB 87FGAMT (15-120 rps)	6,52 Kw - 55,4 Kw	22.226 - 189.059	3,29	1.398,00 \$

ELECTRONIC OIL LEVEL DETECTOR

Model	Brand	Price
OS-1 (Oil level Main Module)	INTRONICS	87,05 \$
03UEAF (Modbus Setting Screen)	INTRONICS	78,02 \$

DC INVERTER CONTROL

Model	Brand	Voltage	Price
IBC-A35-4-01A (ANB33-42-52-66-78)	Mitsubishi	380V-50-60Hz	939,67 \$
F015i-4TXB (ANB33-42)	Frecon		1.265,00 \$
F020i-4TXB (ANB52-66-78)			1.298,00 \$
F025i-4TXB (ANB87)			1.536,25 \$

* DC Inverter Control is not included in the compressor price.



MITSUBISHI R404A DC INVERTER SCROLL 400 Volt

Model	Capacity (min-max)		Cop. (60 rps)	Price
	Kw	Btu		
AGB 33FBAMTS (15-120 rps)	0,60 Kw - 3,20 Kw	2.047 - 10.918	2,05	1.066,00 \$
AGB 42FCAMTS (15-120 rps)	1,75 Kw - 11,29 Kw	5.971 - 38.521	2,15	1.159,00 \$
AGB 66FAAMTS (15-120 rps)	1,86 Kw - 16,54 Kw	6.323 - 56.409	2,07	1.348,00 \$
AGB 78FAAMTS (15-120 rps)	2,37 Kw - 19,47 Kw	8.090 - 66.424	2,09	1.393,00 \$
AGB 87FG1MTS (15-120 rps)	3,78 Kw - 23,89 Kw	12,900 - 81.515	2,21	1.420,00 \$

OIL SEPARATOR

Model	Eligibility		Price
	Inverter	Fixed Speed	
MUTO-A2053N	AGB33	AGB33-AGB42-AGB66	119,90 \$
MUTO-A4053N	AGB33-AGB42-AGB66-AGB78	AGB66-AGB78-AGB87	131,54 \$

DC INVERTER CONTROL

Model	Brand	Eligibility	Connection	Price
SDP-042PF 230	MITSUBISHI	SNB 130-172/TNB 220-306	1 x 230V	459,00 \$
SDP-105AC 400		ADB33/AGB33-42	3 x 380V 50-60HZ	776,70 \$
SDP-140AC 400		ANB33-52/ADB66/AGB66		799,70 \$
SDP-220AC 400		ANB78-87/ADB78/AGB78-87	RS485 - MODBUS	856,70 \$

MITSUBISHI R410A DC INVERTER TWIN ROTARY (220V)

Model	Capacity (min-max)		Cop. (60 rps)	Price
	Kw	Btu		
SNB 092FQAMT (15-130rps)	844 W - 6.408 W	2.866 - 21.866	3,06	342,50 \$
SNB 110FGYMT (15-130rps)	850 W - 7.367 W	2.900 - 25.135	3,18	352,00 \$
SNB 130FQYMT (10-130rps)	868 W - 9.670 W	2.960 - 33.025	3,18	361,00 \$
SNB 172FKEMT (15-130rps)	1.330 W - 10.835 W	4.540 - 37.000	3,1	366,00 \$
TNB 220FLHMT (15-120rps)	1.602 W - 14.392 W	5.470 - 49.100	3,24	474,00 \$
TNB 306FPGMT (15-120rps)	2.245 W - 20.676 W	7.660 - 70.550	3,28	641,00 \$

DC INVERTER CONTROL

Model	Brand	Connection	Price
IBC-A35-AT35T4-X2 (AGB78/AGB87)	MITSUBISHI	1 x 230V 50-60HZ RS485 - MODBUS	939,70 \$
F003i-2PHB 18A (SNB130)	FRECON		773,00 \$
F003i-2PHB 13A-R02 (SNB170)			773,00 \$
F007i-2PHB 07C (TNB220)			831,00 \$
F008i-2PHB 09B (TNB306)			896,00 \$

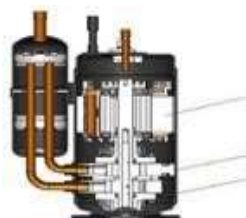

High Efficiency Motor
 Reduced vibration with new fixing internal structure
 PVE oil



MITSUBISHI ROTARY COMPRESSOR R410A

Model	Kw 50 Hz.	BTU 50 Hz.	Voltage	Suction / Discharge		Operation Range	Price
PN 27VAAMT	6.800	23.202	220 V 50 Hz 1 Faz	5/8"	3/8"	OPERATING TEMPERATURE +23°C / -27°C	329,00 \$
PN 33VABMT	8.490	28.968					331,00 \$
NN 40VAAMT	10.200	34.802		3/4"	3/8"		435,00 \$
NN 21YDAMT	5.200	18.000	380 V 50 Hz	5/8"	3/8"		449,50 \$
NN 27YDAMT	6.980	24.000					455,25 \$
NN 31YCAMT	8.060	27.501					459,75 \$
NN 33YCAMT	8.600	29.344					465,00 \$
NN 37YCAMT	9.600	32.000					471,50 \$
NN 40YCAMT	10.400	35.484	3/4"	3/8"	476,20 \$		
NN 44YCAMT	11.400	38.897			483,34 \$		

MITSUBISHI ROTARY COMPRESSOR R410A

Model	Capacitor	BTU	Voltage	Suction / Discharge		Price
RN 110VHSMT	370/25	9.087	220-50 Hz	3/8"	3/8"	218,50 \$
RN 145VHSMT	370/30	12.181		1/2"		252,75 \$
RN 220VHSMT	370/45	18.700		1/2"		299,25 \$

MITSUBISHI ROTARY COMPRESSOR R22

Model	Capacitor	BTU	Voltage	Suction / Discharge		Price
RH 154VHST	370/25	9.087	220-50 Hz	3/8"	5/16"	211,00 \$
RH 207VRFT	400/40	12.290				221,00 \$
RH 313VADT	370/45	19.244				259,25 \$
PH 39VTET	400/60	24.000				309,00 \$



MITSUBISHI SCROLL COMPRESSOR R410A

Model	HP	BTU 50 Hz.	Voltage	Suction / Discharge		Operation Range	Price
AN 30YBFMT	3 HP	26.100	380V	3/4"	1/2"	OPERATING TEMPERATURE +12°C / -20°C 	570,00 \$
AN 33YBFMT	3,3 HP	28.770					581,00 \$
AN 36YBFMT	3,8 HP	32.420					595,00 \$
AN 42YBFMT	4 HP	36.850					612,00 \$
AN 47YBFMT	4,5 HP	41.390					623,00 \$
AN 52YBFMT	5 HP	46.400					647,00 \$
BN 57YFAMT	5,5 HP	52.200		7/8"	824,00 \$		
BN 65YFAMT	6 HP	60.000		868,00 \$			

MITSUBISHI SCROLL COMPRESSOR R410A TANDEM COMPATIBLE

Model	HP	BTU 50 Hz.	Voltage	Suction / Discharge		Operation Range	Price
AN 33YBUMT	3,3 HP	28.770	380V	3/4"	1/2"	OPERATING TEMPERATURE +12°C / -20°C	642,00 \$
AN 42YBUMT	4 HP	36.850					673,00 \$
AN 52YBUMT	5 HP	46.400					710,00 \$
AN 66YQDMT	6,2 HP	60.000		7/8"	725,00 \$		



ALFA LAVAL PLATE HEAT EXCHANGERS

Model	Number of Plate	Price
AC-30EQ-10H	10	218,48 €
AC-30EQ-14H	14	242,60 €
AC-30EQ-20H	20	276,79 €
AC-30EQ-24H	24	298,89 €
AC-30EQ-30H	30	334,40 €
AC-30EQ-36H	36	369,26 €
AC-30EQ-40H	40	394,05 €
AC-30EQ-44H	44	417,51 €
AC-30EQ-54H	54	473,81 €
AC-30EQ-60H	60	510,01 €
AC-220EQ-16AM-F	16	1.014,25 €
AC-220EQ-18AM-F	18	1.018,50 €
AC-220EQ-20AM	20	1.086,40 €
AC-220EQ-28AM-F	28	1.246,75 €
AC-220EQ-36AM	36	1.444,60 €
AC-220EQ-42AM	42	1.597,00 €
AC-220EQ-50AM	50	1.791,00 €
AC-220EQ-76AM	76	5.011,94 €
AC-220EQ-94AM	94	5.915,42 €
AC-220EQ-110AM	110	6.722,06 €

AC-30EQ = 35 bar

AC-220EQ = 32 bar



ALFA LAVAL HIGH-PRESSURE PLATE HEAT EXCHANGERS

Model	Number of Plate	Price
ACH-30EQ-10H	10	237,24 €
ACH-30EQ-14H	14	265,40 €
ACH-30EQ-20H	20	308,95 €
ACH-30EQ-24H	24	337,10 €
ACH-30EQ-30H	30	380,67 €
ACH-30EQ-36H	36	423,53 €
ACH-30EQ-40H	40	437,61 €
ACH-30EQ-44H	44	480,51 €
ACH-30EQ-54H	54	552,22 €
ACH-30EQ-60H	60	566,97 €
ACH-30EQ-80H	80	696,31 €
ACH-220EQ-24AM-F	24	1.235,20 €
ACH-220EQ-36AM	36	1.543,10 €
ACH-220EQ-50AM	50	1.921,20 €
ACH-220EQ-68AM	68	2.405,50 €
ACH-220EQ-86AM	86	2.915,00 €

ACH-30EQ = 50 bar
ACH-220EQ = 45 bar



DANFOSS H SERIES SCROLL COMPRESSOR R404A / R507 - R407C - R134A

Model	Code No	Btu 50 Hz.	Disp. CC	HP	Voltage	Suction Discharge		Oper. Range	Oil Quan. (Lt)	Price
HRP 034 T5LP6	120U2019	28.333	46,21	2,8 Hp	220 V	3/4"	1/2"			
HRP 034 T4LP6	121L2024	28.333	46,21	2,8 Hp	380 V / 400V 50Hz 460V 60Hz	3/4"	1/2"	1,06	678,81 €	
HRP 040 T4LP6	121L1016	33.333	54,4	3,3 Hp		3/4"	1/2"	1,06	697,32 €	
HRP 048 T4LP6	120U1656	38.400	64,4	4 Hp		7/8"	1/2"	1,57	790,29 €	
HRP 060 T4LP6	121L1726	48.000	80,95	5 Hp		7/8"	1/2"	1,57	813,54 €	
HLP 072 T4LC6	121L1756	57.600	98,65	6 Hp		7/8"	1/2"	1,57	866,52 €	
HLP 081 T4LC6	121L1781	64.800	110,94	6,5 Hp		7/8"	3/4"	1,57	911,16 €	
HCP 094 T4LC6	121L0601	75.200	126,02	8 Hp		11/8"	7/8"	2,66	1.283,05 €	
HCP 109 T4LC6	121L0376	87.200	148,79	9 Hp		11/8"	7/8"	2,66	1.329,55 €	
HCP 120 T4LC6	121L0401	96.000	162,4	10 Hp		11/8"	7/8"	2,66	1.376,04 €	

DANFOSS H SERIES TANDEM COMPRESSORS

HRP 048 T4LC8	120U1661	38.400	64,4	4 Hp	380 V / 400V 50Hz 460V 60Hz	7/8"	1/2"	+15°C / -20 °C (MBP)	1,57	790,29 €
HRP 060 T4LC8	120U1731	48.000	80,95	5 Hp		7/8"	1/2"		1,57	839,49 €
HLP 072 T4LC8	120U2072	57.600	98,65	6 Hp		7/8"	1/2"		1,57	953,18 €
HLP 081 T4LC8	121L1786	64.800	110,94	6,5 Hp		7/8"	3/4"		1,57	1.002,27 €
HCP 094 T4LC8	121L0611	75.200	126,02	8 Hp		11/8"	7/8"		2,66	1.481,28 €
HCP 109 T4LC8	121L0386	87.200	148,79	9 Hp		11/8"	7/8"		2,66	1.535,44 €
HCP 120 T4LC8	121L0411	96.000	162,4	10 Hp		11/8"	7/8"		2,66	1.581,47 €

* Compressors are welded. Crankcase heater costs 30,28 Euro. *Subcooling: 0°K, Superheat: 10°K, Refr.: R407C

Model Code No	Voltage	Evaporation		-25°C	-20°C	-15°C	-10°C	-5°C	-0°C	+5°C	+10°C
		Condensation									
HRP 034 T5LP6	380V / 400 V 50 Hz 460 V 60 Hz	40°C		2.002	2.695	3.496	4.430	5.523	6.802	8.292	10.020
		50°C		-	-	2.987	3.818	4.795	5.944	7.290	8.859
HRP 034 T4LP6		40°C		2.129	2.759	3.518	4.424	5.496	6.749	8.203	9.874
		50°C		-	-	2.976	3.779	4.727	5.838	7.130	8.620
HRP 040 T4LP6		40°C		2.445	3.169	4.041	5.082	6.313	7.753	9.423	11.340
		50°C		-	-	3.416	4.338	5.426	6.702	8.185	9.896
HRP 048 T4LP6		40°C		2.971	3.846	4.902	6.165	7.658	9.406	11.430	13.760
		50°C		-	-	4.160	5.279	6.603	8.155	9.961	12.040
HRP 060 T4LP6		40°C		3.726	4.801	6.110	7.681	9.544	11.730	14.260	17.180
		50°C		-	-	5.232	6.612	8.530	10.180	12.430	15.030
HLP 072 T4LC6		40°C		4.746	6.111	7.753	9.719	12.060	14.810	18.030	21.770
		50°C		-	-	6.529	8.184	10.100	12.420	15.170	18.390
HLP 081 T4LC6		40°C		5.051	6.454	8.190	10.290	12.790	15.710	19.100	22.970
		50°C		-	-	7.237	9.130	11.400	14.080	17.210	20.810
HCP 094 T4LC6		40°C		5.720	7.374	9.387	11.800	14.660	18.010	21.890	26.340
		50°C		-	-	8.068	10.220	12.780	15.780	19.280	23.300
HCP 109 T4LC6		40°C		7.254	8.949	11.290	14.240	17.750	21.780	26.280	31.210
		50°C		-	-	9.893	12.300	15.360	19.030	23.270	28.030
HCP 120 T4LC6		40°C		8.045	9.902	12.450	15.640	19.460	23.860	28.820	34.300
		50°C		-	-	10.870	13.410	16.670	20.620	25.250	30.500

DANFOSS SZ SERIES SCROLL COMPRESSOR R407C - R134A

Model	Btu 50 Hz.	Disp. CC	HP	Voltage	Suction Discharge	Oper. Range	Oil Quan. (Lt)	Price
SZ 090-4VI	72.000	120,5	7,5 Hp	380 V / 400V 50Hz 460V 60Hz	1 1/8" 3/4"	+15°C / -20 °C (MBP)	3,3	1.297,79 €
SZ 100-4VI	80.000	127,2	8,0 Hp		1 1/8" 3/4"		3,3	1.349,01 €
SZ 110-4VI	88.000	144,2	9,0 Hp		1 3/8" 7/8"		3,3	1.433,27 €
SZ 120-4VI	96.000	166,6	10 Hp		1 3/8" 7/8"		3,3	1.486,96 €
SZ 125-4RI	104.150	166,6	10 Hp		1 3/8" 7/8"		3,8	1.606,76 €
SZ 148-4VAI	119.800	199,0	12 Hp		1 3/8" 7/8"		3,6	1.710,01 €
SZ 160-4RAI	129.700	216,6	13 Hp		1 5/8" 1 1/8"		4	2.086,36 €
SZ 161-4VAI	129.700	216,6	13 Hp		1 3/8" 7/8"		3,6	1.774,44 €
SZ 175-4RI	140.000	233,0	14 Hp		1 5/8" 1 1/8"		6,2	2.228,62 €
SZ 185-4CAI	148.000	249,9	15 Hp		1 5/8" 1 1/8"		6,2	1.961,14 €
SZ 185-4RI	148.000	249,9	15 Hp		1 5/8" 1 1/8"		6,2	1.961,14 €
SY 240-A4PBI	201.700	347,8	20 Hp		1 5/8" 1 1/8"		8	3.014,41 €
SY 300-A4PBI	248.100	437,5	25 Hp		1 5/8" 1 1/8"		8	3.399,36 €
SY 380-A4CBI	305.800	531,2	30 Hp		2 1/8" 1 3/8"		8,5	3.876,01 €

* Compressors are welded. Crankcase heater costs 30,28 Euro.

* R407C * Watt

Model Code No	Voltage	Evaporation	-20°C	-15°C	-10°C	-5°C	-0°C	+5°C	+10°C	+15°C
		Condensation								
SZ 090-4VI	380V / 400 V 50 Hz 460 V 60 Hz	40°C	6.562	8.540	10.910	13.710	17.010	20.840	25.520	30.290
		50°C	-	-	9.359	11.870	14.810	18.250	22.220	26.780
SZ 100-4VI		40°C	6.976	9.075	11.580	14.550	18.030	22.060	26.710	32.010
		50°C	-	-	9.934	12.590	15.700	19.320	23.500	28.300
SZ 110-4VI		40°C	8.019	10.430	13.290	16.660	20.610	25.170	30.400	36.370
		50°C	-	-	11.390	14.410	17.950	22.040	26.760	32.150
SZ 120-4VI		40°C	9.391	12.250	15.590	19.490	24.020	29.260	35.280	42.160
		50°C	-	-	13.320	16.830	20.900	25.610	31.030	37.230
SZ 125-4VI		40°C	9.237	19.090	15.460	19.410	23.990	29.270	35.310	42.160
		50°C	-	-	13.170	16.730	20.870	25.640	31.100	37.320
SZ 148-4VAI		40°C	11.630	15.020	19.010	23.700	29.180	35.540	42.890	51.300
		50°C	-	-	16.510	20.710	25.620	31.330	37.930	45.530
SZ 160-4RAI		40°C	12.780	16.500	20.910	26.080	32.140	39.140	47.290	56.580
		50°C	-	-	18.130	22.760	28.190	34.500	41.820	50.240
SZ 161-4VAI	40°C	12.580	16.240	20.550	25.620	31.550	38.440	44.640	55.530	
	50°C	-	-	17.850	22.400	27.710	33.890	41.060	49.300	
SZ 175-4CAI	40°C	13.310	17.230	21.870	27.320	33.660	40.970	49.340	58.850	
	50°C	-	-	18.830	23.710	29.400	35.970	43.510	52.00	
SZ 185-4CAI	40°C	14.310	18.520	23.500	29.360	36.170	44.020	53.020	63.240	
	50°C	-	-	20.230	25.480	31.590	38.650	46.750	55.980	
SY 240-A4PBI	40°C	19.310	25.060	31.840	39.810	49.140	59.980	72.490	86.850	
	50°C	-	21.500	27.580	34.700	43.040	52.750	63.990	76.930	
SY 300-A4PBI	40°C	25.040	31.800	39.770	49.140	60.080	72.790	87.460	104.300	
	50°C	-	27.800	34.990	43.450	53.350	64.890	78.250	93.610	
SY 380-A4CBI	40°C	31.210	39.600	49.510	61.140	74.720	90.440	108.500	129.200	
	50°C	-	34.340	43.250	53.690	66.880	80.030	96.360	115.100	

DANFOSS H SERIES R410A SCROLL COMPRESSOR

Model	Code No	Btu 50 Hz.	Disp. CC	HP	Voltage	Suction Discharge	Oper. Range	Oil Quan. (Lt)	Price
HRH 036 U5LP6	121L1176	30.000	34,74	3 Hp	220 V	3/4" 1/2"	+15°C / -20 °C (MBP)	1,06	790,29 €
HRH 036 U4LP6	121L1201	30.000	34,74	3 Hp	380 V / 400V 50Hz 460V 60Hz	3/4" 1/2"		1,06	503,21 €
HRH 040 U4LP6	121L1211	33.300	39,64	3,3 Hp		7/8" 1/2"		1,33	571,33 €
HRH 044 U4LP6	121L1361	36.600	42,61	3,7 Hp		7/8" 1/2"		1,57	604,30 €
HRH 054U4LP6	121L1376	45.000	52,11	4,5 Hp		7/8" 1/2"		1,57	626,28 €
HLH 061 T4LC6	121L2052	50.800	57,78	5,1 Hp		7/8" 1/2"		1,57	619,68 €
HLJ 072 T4LC6	121L1396	60.000	67,97	6 Hp		7/8" 1/2"		1,57	654,84 €
HLJ 083 T4LC6	121L1401	70.000	78,08	7 Hp		7/8" 1/2"		1,57	698,78 €

* Compressors are welded. Crankcase heater costs 30,28 Euro.

* R410A * Watt

Model Code No	Voltage	Evaporation		-25°C	-20°C	-15°C	-10°C	-5°C	-0°C	+5°C	+10°C
		Condensation									
HRH 036	380V / 400 V 50 Hz 460 V 60 Hz	40°C	-	2.794	3.687	4.744	5.981	7.412	9.051	10.910	
		50°C	-	-	-	3.945	5.053	6.329	7.789	9.446	
HRH 040		40°C	-	3.221	4.249	5.468	6.893	8.542	10.430	12.580	
		50°C	-	-	-	4.557	5.836	7.310	8.996	10.910	
HRH 044		40°C	-	3.987	5.147	6.382	7.752	9.317	11.140	13.280	
		50°C	-	-	-	5.206	6.565	8.014	9.613	11.420	
HRH 054		40°C	-	4.915	6.344	7.867	9.555	11.480	13.730	16.360	
		50°C	-	-	-	6.419	8.094	9.881	11.850	14.080	
HLH 061		40°C	3.880	5.429	7.003	8.663	10.550	12.680	15.160	18.060	
		50°C	-	-	5.323	7.133	8.991	10.980	13.170	15.640	
HLJ 072	40°C	4.658	6.516	8.405	10.420	12.660	15.220	18.190	21.680		
	50°C	-	-	6.393	8.566	10.800	13.180	15.810	18.790		
HLJ 083	40°C	5.367	7.525	9.713	12.040	14.630	17.580	21.020	25.050		
	50°C	-	-	7.329	9.832	12.400	15.130	18.150	21.570		

Type	Size	Motor	Spec.	Other Spec.				
HRH	036	U1L	P6	Oil sight glass	Oil stabilization	Oil Drain	LP service port	Gas equalization port
Application: _____				6	No	No	No	No
Product Group: _____				7	Threaded	No	No	No
Refrigerant and Lubricant: _____				8	No	Brazed	No	Brazed
Model Variation: _____				Piping and Electrical Connections:				
T: Optimized design for 7.2/54.4°C				P: brazed connections, lug terminals				
U: Optimized design for 7,2/37,8°C				C: brazed connections, lug terminals				
				Motor Protection:				
				L: internal motor protection				
				Motor Voltage Code:				
				1: 208-230V/1-/60 Hz				
				2: 200-220V/3-/50 Hz & 208-230V/3-/60 Hz				
				4: 380-400V/3-/50 Hz & 460V/3-/60 Hz				
				5: 220-240V/1-/50 Hz				
				7: 500V/3-/50 Hz & 575V/3-/60 Hz 9: 380V/3-/60 Hz				

Nominal Capacity: _____
BIN BTU/SA at 60 Hz bee conditions.

DANFOSS DSH SERIES R410A SCROLL COMPRESSOR

Model	Code No	Btu 50 Hz.	Disp. CC	HP	Voltage	Suction Discharge	Oper. Range	Oil Quan. (Lt)	Price
DSH 090 A4ALD	120H1511	76.730	88,4	8,0 Hp	380 V / 400V 50Hz 460V 60Hz	11/8" 7/8"	+25°C / -30 °C (MBP)	3	1.384,94 €
DSH 105 A4ALD	120H1521	90.300	103,5	9,0 Hp		13/8" 7/8"		3,3	1.553,73 €
DSH 120 A4ALD	120H1531	102.500	116,9	10 Hp		13/8" 7/8"		3,3	1.638,12 €
DSH 140 A4ALD	120H1541	116.400	133,0	12 Hp		13/8" 7/8"		3,3	1.850,61 €
DSH 161 A4ALD	120H1551	133.500	151,7	13 Hp		13/8" 7/8"		3,3	1.985,49 €
DSH 184 A4ALD	120H1561	149.100	170,3	15 Hp		13/8" 7/8"		3,6	2.063,10 €
DSH 240 A4APC	120H1374	201.500	227,6	20 Hp		15/8" 11/8"		6,1	3.024,33 €
DSH 295 A4APC	120H1370	246.500	276,5	25 Hp		15/8" 11/8"		6,1	3.296,10 €
DSH 381 A4APD	120H1366	311.900	345,0	30 Hp		15/8" 11/8"		6,1	3.925,58 €
DSH 485 C4APC	120H1362	401.000	442,6	40 Hp		15/8" 1 3/8"		6,1	5.149,84 €
DSH 600 B4APC	120H1786	493.200	553,0	50 Hp		21/8" 1 3/8"		6,1	5.939,05 €

*Refr.: 410A, 7,2 °C / 54,4°C Superheat: 11,1°K, Subcooling: 8,3°K

DANFOSS SH SERIES R410A SCROLL COMPRESSOR

Model	Code No	Btu 50 Hz.	Disp. CC	HP	Voltage	Suction Discharge	Oper. Range	Oil Quan. (Lt)	Price
SH 090 A4ALC	120H0003	76.100	88,4	8,0 Hp	380 V / 400V 50Hz 460V 60Hz	11/8" 7/8"	+15°C / -30 °C (MBP)	3	1.336,62 €
SH 105 A4ALC	120H0211	91.500	103,5	9,0 Hp		13/8" 7/8"		3,3	1.505,13 €
SH 120 A4ALC	120H0013	102.400	116,9	10 Hp		13/8" 7/8"		3,3	1.589,40 €
SH 140 A4ALC	120H0201	118.400	132,9	12 Hp		13/8" 7/8"		3,3	1.802,53 €
SH 161 A4ALC	120H0023	132.400	151,7	13 Hp		13/8" 7/8"		3,3	1.937,19 €
SH 184 A4ALC	120H0361	152.600	170,3	15 Hp		15/8" 11/8"		6,7	2.014,84 €
SH 240 A4ABE	120H0299	203.800	227,6	20 Hp		15/8" 11/8"		6,7	3.024,33 €
SH 295 A4ABE	120H0827	249.800	276,5	25 Hp		15/8" 11/8"		6,7	3.296,10 €
SH 380 A4ABE	120H0255	308.900	345,0	30 Hp		15/8" 11/8"		6,7	3.925,58 €
SH 485 A4ABA	120H1064	397.300	442,6	40 Hp		15/8" 1 3/8"		6,7	5.149,84 €

* Compressors are welded. Crankcase heater costs 30,28 Euro.

DANFOSS MLZ SERIES R404A SCROLL COMPRESSOR

Model Code No	Evaporation	-25°C	-20°C	-15°C	-10°C	-5°C	-0°C	+5°C	+10°C
	Condensation								
MLZ 015	40°C	1.900	2.400	3.000	3.700	4.400	5.300	6.300	7.400
	50°C	-	1.800	2.400	2.900	3.600	4.300	5.100	6.000
MLZ 021	40°C	2.800	3.500	4.300	5.100	6.200	7.300	8.700	10.300
	50°C	-	2.900	3.500	4.300	5.100	6.100	7.300	8.600
MLZ 026	40°C	3.500	4.300	5.300	6.400	7.700	9.200	10.900	12.800
	50°C	-	3.600	4.400	5.300	6.400	7.700	9.100	10.700
MLZ 030	40°C	4.200	5.200	6.400	7.700	9.300	11.100	13.100	15.400
	50°C	-	4.300	5.300	6.400	7.700	9.200	11.000	12.900
MLZ 038	40°C	5.000	6.200	7.600	9.200	11.100	13.200	15.600	18.400
	50°C	-	5.100	6.300	7.700	9.200	11.000	13.100	15.400
MLZ 045	40°C	6.100	7.500	9.100	11.100	13.300	15.900	18.800	22.000
	50°C	-	6.200	7.600	9.200	11.100	13.200	15.700	18.500
MLZ 048	40°C	6.600	8.200	10.000	12.100	14.500	17.300	20.500	24.200
	50°C	-	6.800	8.300	10.100	12.100	14.400	17.100	20.300
MLZ 058	40°C	7.600	9.300	11.600	14.300	17.400	20.900	24.800	29.000
	50°C	-	7.100	9.000	11.300	14.000	17.000	20.300	23.900
MLZ 066	40°C	9.000	11.200	13.600	16.500	19.800	23.600	27.900	32.800
	50°C	-	9.200	11.400	13.800	16.600	19.700	23.300	27.400
MLZ 076	40°C	10.600	13.100	15.900	19.100	22.900	27.200	32.300	38.200
	50°C	-	11.000	13.000	15.400	18.300	21.800	25.900	30.800



DANFOSS MLZ SERIES BLUE R404A SCROLL COMPRESSOR

Model	Code No	Disp. CC	P I	Voltage	Suction Discharge	Refr.	Oper. Range	Oil Quan. (Lt)	Price
MLZ 015 T5LP9A	121L8631	33,8	2,0 Hp	220 V 50HZ	3/4" 1/2"	R22 R407C R134A R404A	+10°C / -25 °C (MBP)	1,1	602,27 €
MLZ 021 T5LP9A	121L8635	46,2	3,0 Hp		3/4" 1/2"				602,27 €
MLZ 030 T5LC9A	121L8643	68,8	4,0 Hp		7/8" 1/2"				717,91 €
MLZ 038 T5LC9A	121L8647	81,0	5,0 Hp		7/8" 1/2"				761,27 €

MLZ 015 T4LP9A	121L8629	33,8	2,0 Hp	380 V / 400V 50Hz 460V 60Hz	3/4" 1/2"	R22 R407C R134A R404A	+10°C / -25 °C (MBP)	1,1	551,68 €
MLZ 021 T4LP9A	121L8633	46,2	3,0 Hp		3/4" 1/2"				566,13 €
MLZ 026 T4LP9A	121L8637	57,1	3,5 Hp		3/4" 1/2"				623,95 €
MLZ 030 T4LC9A	121L8641	68,8	4,0 Hp		7/8" 1/2"			1,6	655,27 €
MLZ 038 T4LC9A	121L8645	81,0	5,0 Hp		7/8" 1/2"				708,25 €
MLZ 045 T4LC9A	121L8649	98,6	6,0 Hp		7/8" 1/2"				758,85 €
MLZ 048 T4LC9A	121L8651	107,5	7,0 Hp		7/8" 3/4"				876,89 €
MLZ 058 T4LC9A	121L8653	126,0	7,5 Hp		1 1/8" 7/8"			2,7	1.019,03 €
MLZ 066 T4LC9A	121L8657	148,8	9,0 Hp		1 1/8" 7/8"				1.175,62 €
MLZ 076 T4LC9A	121L8655	162,4	10 Hp		1 1/8" 7/8"				1.233,44 €

* Compressors are welded. Valve set and crankcase heater are optional.

Crankcase Heater	All Models for 230 V	30,28 €
------------------	----------------------	----------------

DANFOSS LLZ SERIES LIQUID INJECTED SCROLL COMPRESSORS R404A / R507 / R452A

Model	Code No	m ³ /h	HP	Voltage	Refr.	Suction Discharge	Oper. Range	Oil Quant.	Price
LLZ 013 T4LQ9	121L9535	11,7	4 Hp	380 V / 400V 50HZ 460V 60HZ	R404A / R507 / R452A	1"1/4 & 7/8" 1" & 5/8"	-10°C / -40 °C (LBP)	1,62 Lt	1.087,96 €
LLZ 015 T4LQ9	121L9537	14,5	5 Hp						1.074,02 €
LLZ 018 T4LQ9	121L9539	17	6 Hp						1.195,88 €
LLZ 024 T4LQ9	121L9505	20,9	8 Hp			1"3/4 & 1 3/8" 1"1/4 & 7/8"		2,51 Lt	1.340,44 €
LLZ 034 T4LQ9	121L9543	29,4	10 Hp						1.570,70 €

Aksesuarlar

Fiyat

Note: Accessories are not included in the compressor price.

- 1) Liquid Injection Valve TREV Y1037 **189,29 €**
- 2) Discharge Thermostat Kit 7750009 **57,05 €**
- 3) Crankcase Heater 220 V Ø185 **30,28 €**

50 Hz, EN 12900 Superheat 10 K

* Watt *R404A

Model	Voltage	Evap.	-40°C	-35°C	-30°C	-25°C	-20°C	-15°C	-10°C
		Cond.							
LLZ 013 T4LQ9	380 V / 400 V 50 Hz 460V 60 Hz	40°C	1.846	2.417	3.095	3.899	4.848	5.961	7.259
		50°C	-	1.915	2.483	3.154	3.949	4.885	5.987
LLZ 015 T4LQ9		40°C	2.267	2.937	3.754	4.745	5.936	7.353	9.025
		50°C	-	2.343	3.013	3.825	4.803	5.977	7.376
LLZ 018 T4LQ9		40°C	2.665	3.453	4.415	5.580	6.980	8.646	10.612
		50°C	-	2.755	3.543	4.497	5.648	7.029	8.673
LLZ 024 T4LQ9		40°C	3.405	4.411	5.639	7.127	8.915	11.044	13.555
		50°C	-	3.519	4.526	5.745	7.215	8.978	11.079
LLZ 034 T4LQ9		40°C	4.698	6.051	7.683	9.649	12.008	14.823	18.156
		50°C	-	4.755	6.099	7.702	9.622	11.920	14.660

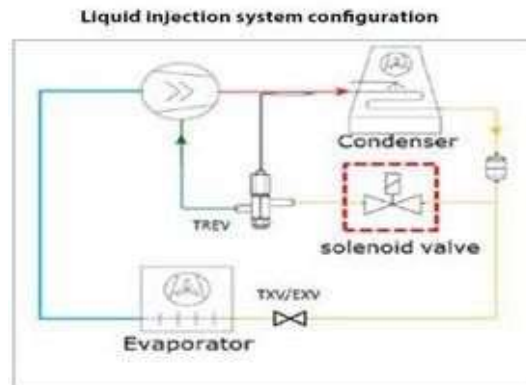

DANFOSS NTZ SERIES R404A HERMETIC PISTON COMPRESSORS

Model	Code No	Disp. CC	HP	Voltage	Valve Connection				Number Cylinder	Oper. Range	Oil Quan. (Lt)	Price (Rotolock Connection)
					Suction		Discharge					
					Rot.	Outlet	Rot.	Outlet				
NTZ 048	120F0226	48	1,8 Hp	380 V / 400V 50HZ 460V 60HZ	11/4"	5/8"	1"	1/2"	1	-10°C / -45 °C (LBP)	0,95	532,02 €
NTZ 068	120F0230	68	2,3 Hp			5/8"		1/2"				
NTZ 096	120F0234	96	3,5 Hp		13/4"	7/8"	11/4"	3/4"				2
NTZ 108	120F0238	108	3,75 Hp			7/8"		3/4"				
NTZ 136	120F0236	136	4,0 Hp			11/8"		3/4"	4	3/4"	3,9	740,67 €
NTZ 215	120F0240	215	6,1 Hp			11/8"		3/4"				
NTZ 271	120F0242	271	8,5 Hp		11/8"	3/4"				1.251,83 €		
												1.396,92 €

* Compressor prices do not include valve and crankcase heater.

* Watt *R404A

Model	-45°C	-40°C	-35°C	-30°C	-25°C	-20°C	-15°C	-10°C
NTZ 048	190	420	710	1.240	1.700	2.860	3.570	3.570
NTZ 068	520	870	1.290	2.110	2.785	4.490	5.540	5.540
NTZ 096	-	910	1.420	2.430	3.360	5.900	7.550	7.550
NTZ 108	-	1.120	1.770	3.010	4.080	6.800	8.530	8.530
NTZ 136	-	1.570	2.360	3.890	5.200	8.570	10.710	10.710
NTZ 215	1.190	2.240	3.540	5.970	8.030	13.220	16.420	16.420
NTZ 271	2.210	3.470	5.140	8.380	11.050	17.840	22.040	22.040

* 45°C condensation

1/2"	Rotolock Connection = 1"		19,47 €
5/8" - 3/4"	Rotolock Connection = 1 1/4"		29,62 €
7/8" - 1 1/8"	Rotolock Connection = 1 3/4"		38,84 €
Crankcase Heater	All Models for 230 V		30,28 €



DANFOSS MTZ SERIES HERMETIC PISTON COMPRESSORS CAPACITY CHART

Model Code No	Voltage	Evaporation	-30°C	-25°C	-20°C	-15°C	-10°C	-5°C	-0°C	+5°C	+10°C
		Condensation									
MTZ 18 4VI	380 V / 400 V 50 Hz 460 V 60 Hz	40°C	469	761	1.133	1.597	2.164	2.847	3.659	4.613	5.720
		50°C	313	546	839	1.203	1.651	2.195	2.848	3.623	4.531
MTZ 22 4VI		40°C	774	1.156	1.643	2.251	2.995	3.891	4.954	6.201	7.647
		50°C	515	809	1.187	1.665	2.259	2.985	3.857	4.892	6.106
MTZ 28 4VI		40°C	963	1.503	2.159	2.951	3.896	5.011	6.315	7.826	9.562
		50°C	570	1.012	1.546	2.193	2.969	3.892	4.982	6.254	7.728
MTZ 32 4VI		40°C	1.271	1.864	2.589	3.464	4.509	5.745	7.191	8.867	10.790
		50°C	828	1.308	1.893	2.603	3.457	4.476	5.979	7.085	8.715
MTZ 36 4VI		40°C	1.554	2.243	3.073	4.067	5.245	6.630	8.241	10.100	12.230
		50°C	1.046	1.624	2.311	3.125	4.089	5.225	6.552	8.093	9.868
MTZ 40 4VI		40°C	1.885	2.659	3.581	4.674	5.959	7.461	9.200	11.200	13.480
		50°C	1.314	1.968	2.734	3.635	4.693	5.930	7.370	9.033	10.940
MTZ 44 4VI		40°C	1.663	2.460	3.433	4.613	6.033	7.724	9.717	12.040	14.740
		50°C	1.062	1.735	2.543	3.517	4.689	6.090	7.753	9.708	11.990
MTZ 50 4VI		40°C	2.021	2.922	4.047	5.430	7.106	9.112	11.480	14.260	17.460
		50°C	1.390	2.108	2.997	4.093	5.432	7.050	8.981	11.260	13.930
MTZ 56 4VI		40°C	2.074	3.049	4.266	5.765	7.588	9.776	12.370	15.410	18.950
		50°C	1.414	2.205	3.182	4.386	5.859	7.643	9.778	12.310	25.270
MTZ 64 4VI		40°C	2.602	3.744	5.160	6.900	9.017	11.560	14.580	18.310	22.250
		50°C	1.730	2.667	3.813	5.224	6.950	9.043	11.550	14.530	18.030
MTZ 72 4VI	40°C	3.007	4.262	5.828	7.752	10.080	12.860	16.150	19.970	24.390	
	50°C	2.135	3.123	4.364	5.903	7.789	10.070	12.790	15.990	19.730	
MTZ 80 4VI	40°C	3.722	5.206	7.003	9.162	11.730	14.770	18.310	22.410	27.120	
	50°C	2.646	3.873	5.344	7.108	9.215	11.710	14.650	18.080	22.050	
MTZ 100 4VI	40°C	3.917	5.730	7.937	10.600	13.790	17.560	21.970	27.100	33.000	
	50°C	2.532	4.102	5.953	8.184	10.750	13.820	17.430	21.640	26.500	
MTZ 125 4VI	40°C	5.457	7.649	10.380	13.720	17.760	22.570	28.240	34.840	42.460	
	50°C	3.927	5.648	7.800	10.460	13.720	17.640	22.320	27.820	34.230	
MTZ 144 4VI	40°C	6.685	9.282	12.440	16.250	20.790	26.140	32.400	39.650	47.970	
	50°C	4.764	6.870	9.422	12.510	16.210	20.610	25.800	31.870	38.900	
MTZ 160 4VI	40°C	7.339	10.190	13.650	17.810	22.760	28.600	35.420	43.310	52.370	
	50°C	5.254	7.584	10.400	13.790	17.850	22.670	28.360	34.990	42.660	

* Subcooling: 0°K, Superheat: 10°K



DANFOSS MTZ SERIES HERMETIC PISTON COMPRESSORS R404A / R507 - R407C - R134A - R22 - R417A

Model Code No	Disp. CC	HP	Voltage	Valve Connection				Number of Cyl.	Oper. Range	Oil Quant. (Lt)	Price (Rotolock Connection)
				Suction		Discharge					
				Rot.	Outlet	Rot.	Outlet				
MTZ 18 5VI	30,23	1,5 Hp	220-230V 50 Hz.	1"	1/2"	1"	3/8"	1	+10 °C / -30 °C (MBP)	0,95	485,87 €
MTZ 22 5VI	38,12	2,0 Hp		1"	1/2"	1"	3/8"				499,79 €
MTZ 28 5VI	48,06	2,3 Hp		1"	5/8"	1"	1/2"				578,49 €
MTZ 32 5VI	53,86	2,7 Hp		1 1/4"	5/8"	1"	1/2"				603,15 €
MTZ 36 5VI	60,47	3,0 Hp		1 1/4"	5/8"	1"	1/2"				634,45 €

Prices do not include the electrical box.

Electric Box	All Models for 230 V	74,80 €
--------------	----------------------	----------------

MTZ 18 4VI	30,23	1,5 Hp	380 V / 400V 50Hz. 460V 60Hz.	1"	1/2"	1"	3/8"	1	+10 °C / -30 °C (MBP)	0,95	479,87 €
MTZ 22 4VI	38,12	1,8 Hp		1"	1/2"	1"	3/8"				499,79 €
MTZ 28 4VI	48,06	2,3 Hp		1"	5/8"	1"	1/2"				526,33 €
MTZ 32 4VI	53,86	2,7 Hp		1 1/4"	5/8"	1"	1/2"				548,15 €
MTZ 36 4VI	60,47	3,0 Hp		1 1/4"	5/8"	1"	1/2"	576,60 €			
MTZ 40 4VI	67,89	3,5 Hp		1 1/4"	5/8"	1"	1/2"	618,32 €			
MTZ 44 4VI	76,22	3,75 Hp		1 3/4"	7/8"	1 1/4"	3/4"	2		697,99 €	
MTZ 50 4VI	85,64	4,0 Hp		1 3/4"	7/8"	1 1/4"	3/4"			723,59 €	
MTZ 56 4VI	96,13	4,6 Hp		1 3/4"	7/8"	1 1/4"	3/4"	4		763,43 €	
MTZ 64 4VI	107,71	5,0 Hp		1 3/4"	7/8"	1 1/4"	3/4"			826,01 €	
MTZ 72 4VI	120,94	6,0 Hp		1 3/4"	7/8"	1 1/4"	3/4"			956,88 €	
MTZ 80 4VI	135,78	6,5 Hp		1 3/4"	1 1/8"	1 1/4"	3/4"			977,74 €	
MTZ 100 4VI	171,26	8,5 Hp		1 3/4"	1 1/8"	1 1/4"	3/4"	3,9		1.531,58 €	
MTZ 125 4VI	215,44	10 Hp		1 3/4"	1 1/8"	1 1/4"	3/4"			1.816,08 €	
MTZ 144 4VI	241,87	12 Hp		1 3/4"	1 1/8"	1 1/4"	3/4"			1.891,95 €	
MTZ 160 4VI	271,55	13 Hp		1 3/4"	1 1/8"	1 1/4"	3/4"			2.031,35 €	

* Compressor prices do not include valve, crankcase heater and electrical box.

3/8" - 1/2" - 5/8"	Rotolock Connection = 1"		19,47 €
5/8" - 3/4" - 7/8"	Rotolock Connection = 1 1/4"		29,62 €
7/8" - 1 1/8" - 1 3/8"	Rotolock Connection = 1 3/4"		38,84 €
1 5/8"	Rotolock Connection = 2 1/4"		120,10 €
Crankcase Heater	All Models for 230 V		30,28 €



DANFOSS COMMERCIAL COMPRESSORS

R134a (*) HMBP | HBP - 50 Hz

Model	Code	Disp. (cm ³)	HP	App.	Voltage	Motor	Cooling Capacity						Price	
							W/W COP Evaporation Temperature °C							
							CECOMAF (W)				ASHRAE			
							-25	-15	5		10	7,2		
W	COP	W	COP											
GL 90TB	123B1533	8,85	1/4	HMBP	220-240V 50Hz	CSIR	143	259	660	1,90	796	787	2,20	86,52 €
GP 14TB	123B1712	14,17	3/8	HBP		CSIR	191	373	998	1,76	1208	1192	2,03	97,97 €
GP 16TB	123B1713	16,15	3/8	HBP		CSIR	-	476	1204	1,80	1451	1435	2,09	122,15 €
GPY 16RAa	123B1542	16,15	1/2	HMBP		CSIR	307	542	1317	2,02	1574	1564	2,34	148,87 €
GX 23TB	123B1547	23,2	3/4	HMBP		CSIR	368	677	1729	1,88	2082	2060	2,18	203,58 €
GS 34TB-V	123B1607	34,42	1	HMBP		CSR	476	1068	2850	2,26	3420	3407	2,62	268,47 €

R404A - R507 HMBP | HBP - 50 Hz

Model	Code	Disp. (cm ³)	HP	App.	Voltage	Motor	Cooling Capacity						Price	
							W/W COP Evaporation Temperature °C							
							CECOMAF (W)				ASHRAE			
							-25	-15	5		10	7,2		
W	COP	W	COP											
MPT 12RA	123B2518	12,1	3/8	HMBP	220-240V 50Hz	CSR	437	723	1559	1,91	1823	1950	2,35	115,79 €
MPT 14RA	123B2704	14,32	1/2	HBP		CSR	-	789	1750	1,78	2068	2199	2,20	156,49 €
MX 16TBa	123B2706	16,03	3/4	HMBP		CSR	481	814	1868	1,74	2212	2350	2,15	192,12 €
MX 21TBa	123B2708	20,72	1	HBP		CSR	621	1046	2410	1,74	2856	3032	2,15	201,02 €
MS 26TB-V	123B2536	25,93	1 3/8"	HMBP		CSR	671	1288	3164	2,00	3767	3991	2,46	267,21 €
MS 34TB-V	123B2712	34,42	1 5/8"	HBP		CSR	-	1850	4205	1,89	4930	5266	2,30	263,36 €
MS 34T3-V	123B2539	34,42	1 5/8"	HMBP	400/440V 50/60Hz	3 PHASE	1002	1850	4205	1,79	4930	5266	2,20	277,37 €

R404A LBP - 50 Hz

Model	Code	Disp. (cm ³)	HP	App.	Voltage	Motor	Cooling Capacity						Price	
							W/W COP Evaporation Temperature °C							
							CECOMAF (W)				ASHRAE			
							-40	-30	-25		-10	-23,3		
W	COP	W	COP											
ML 80FB	123B2111	8,1	1/4	LBP	220-240V 50Hz	CSIR	99	189	251	0,77	505	371	1,09	104,33 €
ML 90FB	123B2115	8,85	1/3	LBP		CSIR	104	207	275	0,83	548	407	1,16	109,42 €
MLY 12LAa	123B2119	10,7	3/8	LBP		CSR	156	294	387	0,94	762	570	1,33	118,33 €
MP 14FB	123B2124	14,17	1/2	LBP		CSIR	121	304	421	0,79	877	625	1,12	123,41 €
MPT 14LA	123B2126	14,32	1/2	LBP		CSR	242	419	534	0,99	984	775	1,38	161,58 €
MPT 16LA	123B2127	16,15	1/2	LBP		CSR	245	462	605	1,00	1168	885	1,40	171,76 €
MX 23FBa	123B2132	23,2	3/4	LBP		CSR	259	534	718	0,96	1455	1064	1,35	216,32 €
MS 34FB-V	123B2172	34,42	1	LBP		CSR	242	759	1083	0,95	2311	1625	1,35	258,29 €

DANFOSS BOCK SEMI-HERMETIC COMPRESSORS

Compressor Model	Displacement (m ³ /h)	HP	Cooling Capacity (Qo) (kW)								Price
			Tc \ Te	0°C	-5°C	-10°C	-15°C	-20°C	-25°C	-30°C	
HGX12P/60-4S	5,4	2	40°C	4,2	3,43	2,77	2,2	1,71	1,3	0,959	
			50°C	3,4	2,75	2,2	1,73	1,33	0,994	0,722	
HGX12P/75-4S	6,7	2,5	40°C	5,31	4,38	3,57	2,87	2,27	1,76	1,33	
			50°C	4,35	3,57	2,89	2,31	1,81	1,39	1,05	
HGX12P/90-4S	8	3	40°C	6,35	5,42	4,28	3,45	2,73	2,13	1,63	
			50°C	5,22	4,29	3,48	2,79	2,2	1,71	1,3	
HGX12P/110-4S	9,4	3	40°C	7,37	6,1	4,99	4,03	3,21	2,5	1,91	
			50°C	6,01	4,94	4,02	3,23	2,55	1,98	1,49	
HGX22e/125-4S	11,1	3	40°C	8,97	7,44	6,08	4,87	3,81	2,89	2,12	
			50°C	7,39	6,07	4,9	3,87	2,98	2,23	1,61	
HGX22e/160-4S	13,7	4,1	40°C	11,2	9,25	7,51	5,98	4,65	3,51	2,57	€ 1.439,00
			50°C	9,15	7,49	6,01	4,73	3,62	2,7	1,94	
HGX22e/190-4S	16,5	4,1	40°C	13,7	11,4	9,27	7,49	5,95	4,64	3,54	€ 1.492,00
			50°C	11,3	9,24	7,51	6,02	4,74	3,65	2,75	
HGX34e/215-4S	18,8	5	40°C	15,3	12,5	9,99	7,91	6,13	4,64	3,41	€ 1.697,00
			50°C	12,2	9,84	7,82	6,11	4,68	3,49	2,52	
HGX34e/255-4S	22,1	6	40°C	18,1	14,8	11,9	9,42	7,29	5,51	4,04	€ 1.580,00
			50°C	14,6	11,8	9,4	7,35	5,61	4,17	3,01	
HGX34e/315-4S	27,3	7	40°C	22	18,1	14,8	11,9	9,32	7,18	5,37	€ 1.786,00
			50°C	17,8	14,6	11,8	9,37	7,29	5,53	4,04	
HGX34e/380-4S	33,1	9	40°C	26,7	22,2	18,2	14,8	11,8	9,16	6,98	€ 2.038,00
			50°C	21,8	18	14,7	11,8	9,33	7,21	5,39	
HGX44e/475-4S	41,3	12	40°C	34,6	28,6	23,4	18,9	15,1	11,9	9,03	€ 2.621,00
			50°C	28,5	23,4	19	15,2	12,1	9,3	6,98	



DANFOSS BOCK SEMI-HERMETIC COMPRESSORS

Compressor Model	Displacement (m³/h)	HP	Cooling Capacity (Qo) (kW)								Price	
			Tc \ Te	Te								
				0°C	-5°C	-10°C	-15°C	-20°C	-25°C	-30°C		
HGX44e/565-4S	49,2	15	40°C	41,4	34,3	28,2	22,9	18,3	14,4	11,1	€ 2.831,00	
			50°C	34,2	28,2	23	18,5	14,7	11,5	8,66		
HGX44e/665-4S	57,7	20	40°C	47,9	39,6	32,4	26,2	20,9	16,4	12,5	€ 3.222,00	
			50°C	39,3	32,3	28,2	21	16,6	12,8	9,59		
HGX44e/770-4S	67	22	40°C	55,6	46,1	37,8	30,7	24,5	19,3	14,9	€ 3.666,00	
			50°C	45,7	37,6	30,7	24,7	19,6	15,3	11,8		
HGX56e/850-4S	73,8	25	40°C	61,7	51,2	42	34,1	27,3	21,8	16,6	€ 4.091,00	
			50°C	50,9	41,9	34,2	27,6	22	17,1	13		
HGX56e/995-4S	86,6	30	40°C	72,5	60,1	49,2	39,8	31,6	24,5	18,5	€ 4.535,00	
			50°C	59,4	48,9	39,7	31,8	25	19,1	14,1		
HGX56e/1155-4S	100,4	35	40°C	83,5	69,1	56,7	46	36,8	29	22,3	€ 4.697,00	
			50°C	68,7	56,5	46	37,1	29,4	22,9	17,4		
HGX66e/1340-4S	116,5	37	40°C	98,8	81,9	67,1	54,3	43,1	33,6	25,5	€ 5.837,00	
			50°C	80,7	66,5	54,2	43,5	34,3	26,5	19,9		
HGX66e/1540-4S	133,8	42	40°C	114	94,3	77,5	62,8	50,2	39,3	30	€ 6.393,00	
			50°C	92,9	76,8	62,7	50,6	40,1	31,2	23,6		
HGX66e/1750-4S	152,2	50	40°C	129	108	88,1	71,4	57,1	44,7	34,2	€ 7.034,00	
			50°C	106	87,2	71,3	57,5	45,7	35,6	27		
HGX66e/2070-4S	180	60	40°C	152	126	104	84	67,2	52,7	40,3		
			50°C	124	103	83,6	67,6	53,8	41,9	31,8		
HGX88e/2400-4S	209,1	70	40°C	181	150	124	99,8	79,7	62,4	47,7		
			50°C	149	123	99,9	80,5	63,9	49,8	37,7		
HGX88e/2735-4S	237,9	80	40°C	205	170	140	114	90,5	70,9	54,2		
			50°C	168	139	114	91,4	72,6	56,5	42,8		
HGX88e/3235-4S	281,3	95	40°C	242	201	165	134	107	83,4	63,6		
			50°C	199	164	134	108	85,3	66,3	50,2		

Compressor Model	Displacement (m³/h)	HP	Cooling Capacity (Qo) (kW)						Price		
			Tc \ Te	Te							
				-30°C	-35°C	-40°C	-45°C	-50°C		-55°C	-60°C
HGZX7/1620-4	93,7	25	40°C	33,5	27,4	22,2	18	14,4	11,5	9,05	€ 9.250,00
			50°C		25,9	21	16,9	13,5	10,7	8,34	
HGZX7/1860-4	107,6	30	40°C	38,4	31,4	25,5	20,6	16,6	13,2	10,4	€ 9.500,00
			50°C		29,7	24,1	19,4	15,5	12,3	9,57	
HGZX7/2110-4	122,4	35	40°C	43,7	35,7	29	23,4	18,8	15	11,9	
			50°C		33,8	27,4	22,1	17,7	14	10,9	



DANFOSS COLIBRI ELECTRONIC EXPANSION VALVES ETS 12C - 24C - 25C - 50C - 100C

SPECIFICATIONS:

- * Heat Pump compatible
- * Direct drive motor
- * Stepping motor
- * Fast on and off time
- * Powerful 2-pole motor that can precisely control flow regulation
- * No solenoid valve is needed thanks to its full closing feature
- * Humidity indicator on models with sight glass
- * Does not allow more liquid to pass through than it can vaporize
- * Bi-directional high and full liquid passage



new

ELECTRONIC EXPANSION VALVE

Model	Code No	Capacity R407C Kw	Capacity R22 Kw	Capacity R134a Kw	Capacity R404A Kw	Capacity R410a Kw	Connection Diameter (Ø)	Price
ETS 12C	034G7501	95,1	85,41	68,0	66,49	105,3	5/8" - 5/8"	203,58 €
ETS 12C	034G7502	95,1	85,41	68,0	66,49	105,3	7/8" - 7/8"	203,58 €
ETS 24C	034G7902	165,1	148,3	118,1	115,5	182,8	7/8" - 7/8"	227,52 €
ETS 25C	034G7602	165,1	148,3	118,1	115,5	182,8	7/8" - 7/8"	335,30 €
ETS 50C	034G7701	313,5	281,6	224,3	219,2	347,1	7/8" - 1 1/8"	384,22 €
ETS 50C	034G7702	313,5	281,6	224,3	219,2	347,1	1 1/8" - 1 1/8"	384,22 €
ETS 100C	034G7802	615,6	552,9	440,3	430,4	681,5	1 3/8"-1 3/8"	455,05 €

SUPERHEAT CONTROL (0,5 - 4,5V / 0-10V / 1-5V / 0-20mA)

Model	Code No		Price
EKE 1A	080G5300	Superheat Controller	233,99 €
EKE 1B	080G5350	Superheat Controller (Modbus)	257,29 €
EKE 1C	080G5400	Superheat Controller (Modbus + Canbus)	388,41 €
MMIGRS 2	080G0294	Remote Display	207,71 €
RJ 12	080G9744	MMIGRS Cable 2 Mt. (RJ 12 Socket)	10,86 €
AKS 32R	060G6323	(0-5v -1/12bar) Pressure Transmitter 1/4" Dişi	154,17 €
AKS 33	060G2044	(4-20 Ma -1/9 Bar) Pressure Transmitter	123,32 €
M 12	034G2201	Expansion to Driver Connection Cable	60,98 €
DSTP 110	075G4002	(0-5v -1/12bar) Pressure Transmitter	53,50 €
DSTP 110	075G4007	(0-5v -1/34bar) Pressure Transmitter	53,50 €
DSTP 110	075G4009	(0-5v 0/50bar) Pressure Transmitter	61,00 €
NSK-PP 13	061H5177	Transmitter Cable	14,59 €
S2 SENS	B49-P36-285	NTC 10k Heat Sensor (Metal Tip)	7,82 €
NTC 10K	B49-P36-284	NTC 10k Prob 1,5 Mt. (-50/+50)	4,84 €
AKS 11	084N0028	PT 1000 Sensor 5,5 Mt. (S2 - S4)	29,64 €
ACCPBT	080G0210	PT 1000 Sensor 6 Mt.	27,65 €



DANFOSS ETS 6 ELECTRONIC EXPANSION VALVES

SPECIFICATIONS:

- * Full hermetic design
- * Optimized energy efficiency for the system
- * High resolution precision flow control
- * Compact and lightweight
- * Proven high reliability
- * Two-way flow for Heat Pump applications
- * Does not allow more liquid to pass through than it can vaporize
- * Ability to use with EIM336 and EKD-316



ELECTRONIC EXPANSION VALVE

Model	Code No	Capacity R407C Kw	Capacity R22 Kw	Capacity R134a Kw	Capacity R404A Kw	Capacity R410a Kw	Connection Diameter (Ø)	Price
ETS 6-10	034G5005	2,7	2,6	2,0	1,8	3,1	5/16" - 5/16"	40,78 €
ETS 6-14	034G5015	5,9	5,8	4,5	4,1	6,8	5/16" - 5/16"	50,19 €
ETS 6-18	034G5026	10,6	10,3	8,1	7,3	12,1	1/4" - 1/4"	62,73 €
ETS 6-25	034G5035	20,1	19,6	15,3	13,8	23,0	5/16" - 5/16"	77,37 €
ETS 6-32	034G5055	29,6	28,8	22,5	20,3	33,9	5/16" - 5/16"	96,19 €
ETS 6-40	034G5065	40,2	39,1	30,6	27,6	46,0	5/16" - 5/16"	110,83 €
ETS-6 Bobin	034G5105	(0,7mt cable length) JST XHP-6						24,40 €
ETS-6 Bobin	034G5115	(0,7mt cable length) JST XHP-5						24,40 €
ETS 12,5	034G4210	63	57	45	43	70	5/8" - 5/8"	279,69 €
ETS 25	034G4203	129	117	93	88	144	7/8" - 7/8"	332,84 €
ETS 50	034G1705	240,5	215	170	161,4	262,3	7/8" - 1 1/8"	418,21 €
ETS 100	034G0501	447,8	400,4	316,5	300,5	488,4	1 1/8" - 1 3/8"	461,78 €
ETS 250	034G2602	1.212	1.106	874	828	-	1 5/8"-1 5/8"	709,23 €
ETS 400	034G3500	1.933	1.764	1.394	1.320	-	1 5/8"-1 5/8"	911,36 €

SUPERHEAT CONTROL

Model	Kod No		Fiyat
EIM 336	080G1002	Superheat Controller (MODBUS)	111,79 €
Kablo Seti	080G1601	Connector Kit	54,99 €
AKS 32R	060G6323	(0-5V -1/12Bar Pressure Transmitter 1/4" Dişi	154,17 €
AKS 32R	060G1036	(0-5V -1/12Bar) Pressure Transmitter 1/4" Erkek	154,17 €
AKS 11	084N0028	Temperature Sensor (S2 - S4)	29,64 €
M12	034G2201	Expansion to Driver Connection Cable	60,98 €



* Coil is not included in the prices

AKV 10P

Model	Code No	R744				R407A/R507		R404A		Package Amount	Price
		Cold Containment (kW)	Frozen Containment (kW)	Cold Containment (TR)	Frozen Containment (TR)	kW	TR	kW	TR		
AKV 10P1	068F5211	1.17	1.84	0.33	0.52	0.9	0.26	0.64	0.18	18	113,27 €
AKV 10P2	068F5212	2.06	3.25	0.58	0.92	1.58	0.45	1.12	0.32	18	113,27 €
AKV 10P3	068F5213	3.14	4.97	0.89	1.41	2.41	0.69	1.72	0.49	18	113,27 €
AKV 10P4	068F5214	6.10	9.64	1.74	2.74	4.68	1.33	3.33	0.95	18	113,27 €
AKV 10P5	068F5215	8.49	13.41	2.41	3.81	6.52	1.86	4.64	1.32	18	113,27 €
AKV 10P6	068F5216	15.14	23.90	4.30	6.80	11.60	3.30	8.27	2.35	18	113,27 €
AKV 10P7	068F5217	24.58	38.80	6.99	11.03	18.81	5.35	13.40	3.82	18	113,27 €

AKV Coil

Code No	Specifications	Package Amount	Price
018F6802	240 V a.c. 12W, 50 Hz	24	29,63 €
018F6905	230V a.c. 20 W, 50 Hz	24	41,83 €

AKVH 10

Model	Code No	R744 (CO ₂)		Package Amount	Price
		Cold Storage	Frozen Storage		
AKVH 10-0	068F4078	0,4 kW	0,8 kW	18	139,40 €
AKVH 10-1	068F4079	1,1 kW	2,2 kW	18	139,40 €
AKVH 10-2	068F4080	1,7 kW	3,5 kW	18	139,40 €
AKVH 10-3	068F4081	2,6 kW	5,4 kW	18	139,40 €
AKVH 10-4	068F4082	4,3 kW	8,7 kW	18	139,40 €
AKVH 10-5	068F4083	6,7 kW	13,6 kW	18	139,40 €
AKVH 10-6	068F4084	10,7 kW	21,7 kW	18	139,40 €

* Coil is not included in the prices.

AKV 10

Model	Code No	Nominal Capacity - [Te: +5°C Tc: +32°C]				Package Amount	Price
		R22/R407C	R134a	R404A/R507	R407C		
AKV 10-2	068F1164	1,6 kW	1,4 kW	1,3 kW	1,7 kW	18	113,27 €
AKV 10-4	068F1170	4,1 kW	3,4 kW	3,1 kW	4,0 kW	18	113,27 €
AKV 10-5	068F1173	6,4 kW	5,3 kW	4,9 kW	6,4 kW	18	113,27 €

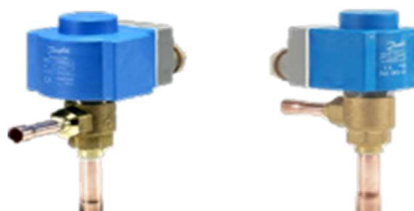

DANFOSS MCX PROGRAMMABLE CONTROLLERS

Model	Analog Input	Relay Number	Analog Output	Digital Input	Specifications	Price
MCX06C	4 ad. 2 ad. Ntc 0/1V,0/5V 2 ad. Ntc, PT1000,0/1V, 0/5V,0/10V,0/20ma, 4-20 ma, On/Off	6 ad. Spst: 6 ad. 5 Amp	2 ad. 1 ad. 0/10Vdc, PWM, PPM 1 ad. PWM, PPM cutting phase	6 ad.		Ask for Price
MCX06D	4 ad. 2 ad. Ntc 0/1V, 0/5V 2 ad. Ntc,PT1000,0/1V, 0/5V,0/10V,0/20 ma, 4-20 ma, On/Off	6 ad. Spst: 5a d. 8 Amp Spdt: 1 ad. 8 Amp	3 ad. 2 ad. 0/10Vdc, PWM, PPM 1ad. PWM, PPM	8 ad.		Ask for Price
MCX061V	7 ad. 3 ad. NTC, Pt1000, 0/1V, 0/5V, 0/10V, ON/OFF, 0/20mA, 4/20mA, 2 ad. NTC, 0/1V, 0/5V, 0/10V, ON/OFF, 0/20mA, 4/20mA, Superheat S1: 0/1V, 0/5V, 0/10V, ON/OFF, 0/20m A, 4/20m A, S2: PT1000, 0/1V, 0/5V, 0/10V, ON/OFF,	6 ad. Spst : 6 ad. 5 Amp	3 ad. 2 ad. 0/10Vdc 1 ad. 0/10Vdc, PWM, PPM	8 ad.		Ask for Price
MCX08M2	8 ad. 4 ad. NTC 0/1 V, 0/5 V 4 ad. NTC, Pt1000, 0/1V, 0/5V, 0/10V, ON/OFF, 0/20mA, 4/20mA,	8 ad. Spst: 2 ad. 8 Amp Spdt: 4 ad. 8 Amp Spst: 2 ad. 16 Amp	4 ad. 2 ad. 0/10Vdc optoisolated 2 ad. PWM, PPM cutting phase	8 ad.	Stepper electronic expansion valve control 	Ask for Price
MCX15B2	10 ad. 4 ad. NTC 0/1 V, 0/5 V, 0/10 V, NTC Table, PT1000 6 ad. NTC, Pt1000, Ni1000, 0/1V, 0/5V, 0/10V, ON/OFF, 0/20mA, 4/20mA	15 ad. Total current 65A SPDT Relay 16A 2 ad. (changeover) SPST Relay 5A 13 ad. (normally open)	6 ad. AO1-AO6 6 ad. 0/10Vdc galvanically isolated, AO5-AO6 2 ad. Asynchronous PWM,	22 ad. 4 ad. 24V optoisolated 4 ad. 230V Optoisolated		Ask for Price
MCX152V	14 ad. 8 ad. NTC, Pt1000, 0/1 V, 0/5 V, 0/10 V, 0/20 mA, 4/20 mA, 6 ad. NTC, 0/1 V, 0/5 V, 0/10 V, 0/20 mA, 4/20 mA, 2 ad. Superheat S1: 0/1 V, 0/5 V, 0/10 V, 0/20 mA, 4/20 mA 2 ad. Superheat S2: PT1000, 0/1 V, 0/5 V, 0/10 V,	15 ad. 12 ad. SPST relay 5A 3 ad. SPDT relay 16A	6 ad. 0/10Vdc 2 ad. 0/10 V, PWM, PPM	18 ad. 16 ad. Voltage free contact 2 ad. 24V optoisolated 2 ad. 230 Vac optoisolated		Ask for Price
MCX20B2	16 ad. 6ad. NTC 0/1 V, 0/5 V, 0/10 V, NTC Table, PT1000 10 ad. NTC, Pt1000, Ni1000, 0/1V, 0/5V, 0/10V, ON/OFF, 0/20mA, 4/20mA	20 ad. Total current 65A SPDT Relay 16A 2 ad. (changeover) SPST Relay 5A 18 ad.(normally open)	6 ad. AO1-AO6 6 ad. 0/10Vdc galvanically isolated, AO5-AO6 2 ad. Asynchronous PWM,	22 ad. 4 ad. 24V optoisolated 4 ad. 230V Optoisolated	2ad. Stepper elektronik expansion valf kontrolü 	Ask for Price

- Central system control
- Screw, piston capacity and system control
- Chiller Heatpump systems
- Air Handling Control

- Dehumidification systems
- Package hygienic and hygienic air handling unit system control
- Heat recovery device control
- Software for all kinds of cooling applications.

DANFOSS THERMOSTATS

Model	Code No	Sensor Type	Relay Outputs	Digital Input	Specifications	Price
ERC 211	080G3454	NTC 5K	1	2AI, 1AI DI, 1DI	Cooling applications (normal-medium-low temperature) Day-night mode 16Amp relay	30,76 €
ERC 213	080G3458	NTC 10K	3			36,81 €
ERC 214	080G3463	PT 1000 PTC	4			42,59 €
AK-RC 204B	080Z5001	OPTYMA CONTROL			230V. AC	154,47 €
NTC TEMPERATURE SENSOR		NTC (10K)	-50°C/110°C	1,5 Mt.		4,70 €
NTC TEMPERATURE SENSOR		NTC (10K)	-50°C/110°C	3,5 Mt.		6,12 €
TEMPERATURE SENSOR METAL TIP		NTC (10K)	-50°C/110°C	1,5 Mt.		7,60 €

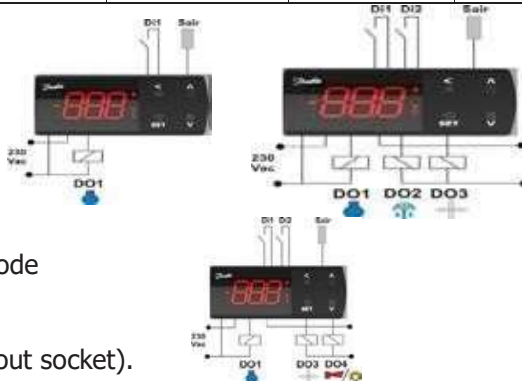

- * Energy efficiency with day night mode
- * Easy menu (4 buttons)
- * Ready-to-use programs.
- * Electrical terminal with screw (without socket).

DANFOSS MECHANICAL THERMOSTATS

Code No	Description	Price
077B7100	Showcase	7,00 €
077B7101	Dispenser / Vertical Cooler / Pool	7,00 €
077B7102	Deep Freeze	7,00 €





KELLER TRANSMITTER



Model	Code No	Signal Type	Pressure Range	Specifications	Price
PA-21Y	222155.0490	4-20mA	0 - 18 Bar	 -40 - 100°C operating range 4pin M12 7/16"- 20UNF female connection	57,50 €
PA-21Y	222155.0026	4-20mA	0 - 30 Bar		57,50 €
PA-21Y	222155.2056	4-20mA	0 - 50 Bar		57,50 €
PA-21C	222120.0173	0-5 V ratio	-1 - 12 Bar		61,75 €
PA-21C	222120.0206	0-5 V ratio	-1 - 30 Bar		61,75 €
PA-21C	222120.0297	0-5 V ratio	0 - 30 Bar		61,75 €
M12 Cable	6140500	---	---	5 mt. 4 x 0.34 Female	15,25 €

SENSORS AND ACCESSORIES

TEMPERATURE SENSORS

Model	Code No	Signal Type	Operation Range	Cable Length	Specifications	Price
AK-HS 1000	084N1007	PT 1000	-30°C / 50°C	5,5 Mt		71,94 €
AKS 21 D	084N2035	PT 1000	-40°C / 80°C	-		467,61 €
EKS 221	084N3200	NTC (10K)	-50°C / 110°C	1,5 Mt		10,54 €

PRESSURE SENSORS

Model	Code No	Signal Type	Operation Range	Connection Type	Specifications	Price
AKS 32	060G2069	0-5V	-1/12 Bar	1/4" Male		213,78 €
AKS 32	060G2155	0-5V	-1/50 Bar	1/4" Male		213,78 €
AKS 33	060G2044	4-20ma	-1/9 Bar	1/4" Male		123,32 €
AKS 33	060G2045	4-20ma	0/25 Bar	1/4" Male		123,32 €
AKS 3000	060G1007	4-20ma	-1/9 Bar	1/4" Male		213,78 €
AKS 3000	060G1325	4-20ma	0/18 Bar	1/4" Male		213,78 €
AKS 3000	060G1327	4-20ma	0/30 Bar	1/4" Male		152,29 €
AKS 3000	060G1328	4-20ma	0/40 Bar	1/4" Male		136,08 €
AKS 32R	060G6323	0-5V	-1/12 Bar	1/4" Female		154,17 €
AKS 32R	060G1036	0-5V	-1/12 Bar	1/4" Male		154,17 €
AKS 32R	060G0090	0-5V	-1/34 Bar	1/4" Male		154,17 €

PRESOSTATS

Model	Code No	Package Amount	Specifications	Price
KP 1	060-110166	36	Low pressure switch, auto reset -0,2/7,5 bar	30,50 €
KP 1	060-110366	36	Low pressure switch, manual reset -0,2/7,5 bar	29,62 €
KP 5	060-117166	36	High pressure switch, auto reset 8 / 32 bar	36,59 €
KP 5	060-117366	36	High pressure switch, manual reset 8 / 32 bar	38,34 €
KP 6W	060-519066	36	High pressure switch, auto reset 8 / 42 bar	78,41 €
KP 6B	060-519166	36	High pressure switch, manual reset 8 / 42 bar	78,41 €
KP 15	060-124166	24	Low - High pressure switch, automatic reset and single signal	59,25 €
KP 15	060-124366	24	Low - High pressure switch, manual reset and single signal	60,98 €
KP 15	060-126566	24	Low - High pressure switch, automatic reset and dual signal	60,98 €
KP 15	060-126466	24	Low - High pressure switch, manual reset and dual signal	67,97 €
MP 54	060B016791	21	Oil pressure switch 60 Sec. $\Delta p = 0,9$ bar (constant)	147,81 €
MP 55	060B017191	21	Oil pressure switch 60 Sec. $\Delta p = 0,3 - 4,5$ bar	168,94 €
MP 55	060B017291	21	Oil pressure switch 90 Sec. $\Delta p = 0,3 - 4,5$ bar	168,94 €
MP 55	060B017391	21	Oil pressure switch 120 Sec. $\Delta p = 0,3 - 4,5$ bar	168,94 €
RT 200L	017L003266	15	Low pressure switch 0,2/ 6 bar	212,51 €
RT 117L	017L004266	15	High pressure switch 10/ 30 bar	349,84 €
KP 35	060-113366	36	Pressure switch -0,2/7,5 bar	26,99 €
KP 36	060-110866	36	Pressure switch 2/14 bar	26,99 €
RT 116	017-520366	12	Pressure switch 1/10 bar	109,50 €

MECHANICAL THERMOSTATS

Model	Code No	Package Amount	Specifications	Price
UT 72	060H1103	24	Operating Thermostat -30°C / +30°C	50,54 €
RT 3	017-501466	15	Room Thermostat -25°C / +15°C	172,41 €
RT 17	017-511766	15	Room Thermostat -50°C / +15°C	169,42 €
RT 140	017-523666	9	Operating Thermostat +45°C / +15°C	201,49 €
KP 61	060L110066	32	Mechanical Thermostat -30°C / +15°C	46,19 €
KP 61	060L110266	32	Mechanical Thermostat -30°C / +13°C	46,19 €
KP 61	060L110366	32	Mechanical Thermostat -30°C / +15°C	57,97 €
KP 62	060L110666	36	Mechanical Thermostat -30°C / +15°C	47,05 €
KP 73	060L111866	32	Room Thermostat -25°C / +15°C	54,90 €
KP 73	060L113866	32	Freeze Thermostat -25°C / +15°C (Manual Reset)	46,52 €



KP 73



KP 61



RT 140



KP 61

Features

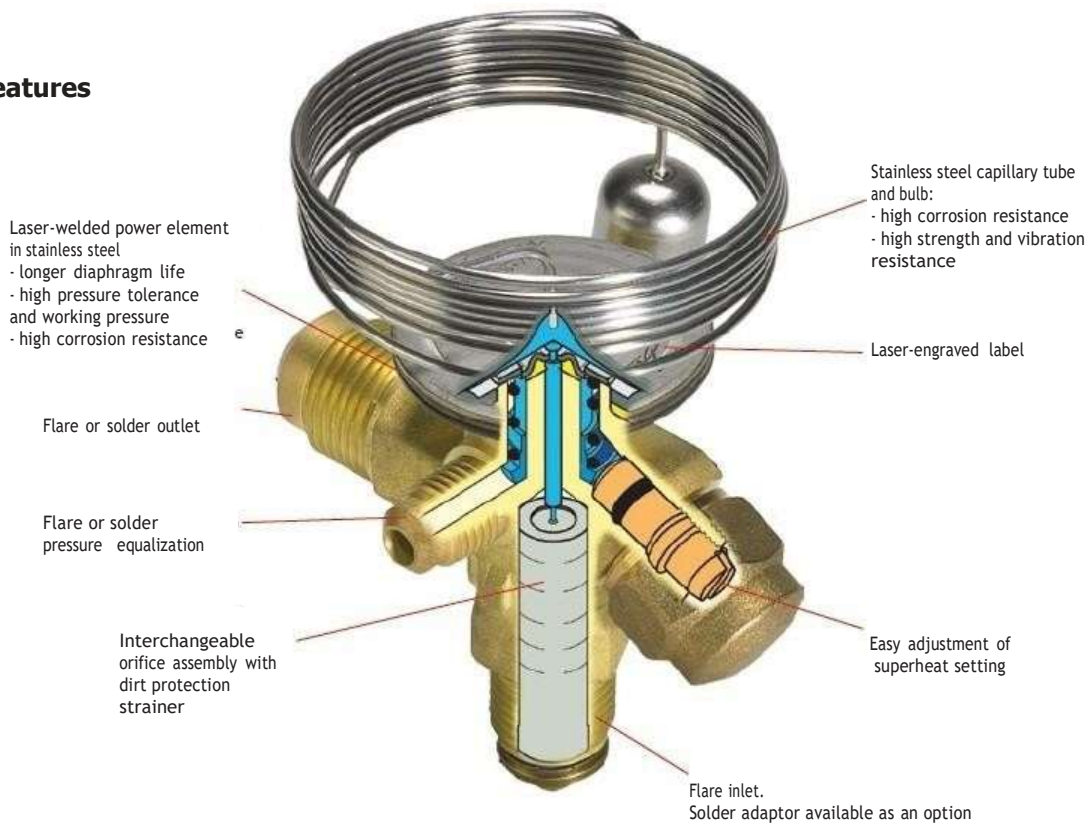

Orifice No	Code No	Package Amount	R134a		R404A		R407C		R22		Price
			Kw	TR	Kw	TR	Kw	TR	Kw	TR	
T2 Orifice 0X	068-2002	25	0,68	0,19	0,64	0,18	0,92	0,26	0,9	0,25	10,46 €
T2 Orifice 00	068-2003	25	1,20	0,34	1,30	0,37	1,80	0,51	1,8	0,51	
T2 Orifice 01	068-2010	25	2,10	0,59	2,60	0,75	3,5	1,00	3,5	0,99	
T2 Orifice 02	068-2015	25	2,50	0,73	3,70	1,10	4,8	1,40	4,7	1,30	
T2 Orifice 03	068-2006	25	4,30	1,20	6,30	1,80	8,1	2,30	8	2,30	
T2 Orifice 04	068-2007	25	6,40	1,80	9,90	2,80	12,4	3,50	12,10	3,50	
T2 Orifice 05	068-2008	25	8,40	2,30	13,00	3,70	16,5	4,70	16,70	4,80	
T2 Orifice 06	068-2009	25	10,10	2,90	15,50	4,40	19,7	5,60	19,70	5,60	

* Capacity values are at +4,4°C evaporation and +38°C condensation conditions

T2 / TE2 EXPANSION VALVES WITH REPLACEABLE ORIFICE

Refr. Type	Connection	Externally equalized	Internally equalized	Range/Mop	Code No	Package Amount	Price	
R404A / R507	Welded		TS2	N	068Z3414	20	40,08 €	
		TES2		N	068Z3415	20	64,48 €	
		TES2		NL -10°C	068Z3430	20	64,48 €	
		TES2		B -20°C	068Z3421	20	64,48 €	
	Threaded			TS2	N	068Z3400	20	40,08 €
				TS2	NM 0°C	068Z3406	20	40,08 €
				TS2	B -20°C	068Z3410	20	40,08 €
		TES2			N	068Z3403	20	64,48 €
		TES2			NM 0°C	068Z3407	20	64,48 €
		TES2			NL -10°C	068Z3409	20	64,48 €
		TES2			B -20°C	068Z3411	20	64,48 €
Refr. Type	Connection	Externally equalized	Internally equalized	Range/Mop	Code No	Package Amount	Price	
R134A	Welded	TEN2		N	068Z3385	20	64,48 €	
			TN2	N	068Z3383	20	40,08 €	
	Threaded			TN2	N	068Z3346	20	40,08 €
		TEN2			N	068Z3348	20	64,48 €
		TEN2			NM 0°C	068Z3392	20	64,48 €
		TEN2			NL -10°C	068Z3370	20	64,48 €
Refr. Type	Connection	Externally equalized	Internally equalized	Range/Mop	Code No	Package Amount	Price	
R22 / R407C	Welded		TX2	N	068Z3281	20	44,43 €	
		TEX2		N	068Z3284	20	71,45 €	
	Threaded			TX2	N	068Z3206	20	44,43 €
		TEX2			N	068Z3209	20	71,45 €
		TEX2			NM 0°C	068Z3225	20	85,74 €
		TEX2			NL -10°C	068Z3227	20	71,45 €
		TEX2			B -20°C	068Z3229	20	83,64 €
Refr. Type	Connection	Externally equalized	Internally equalized	Range/Mop	Code No	Package Amount	Price	
R407C	Welded			N	068Z3446	20	64,48 €	
	Threaded	TEZ2			068Z3501	20		
Refr. Type	Connection	Externally equalized	Internally equalized	Range/Mop	Code No	Package Amount	Price	
R448A R449A	Welded		T2	N	068Z3729	20	68,57 €	
		TE2			068Z3730		71,25 €	

RANGE N -40°C & +10°C
 RANGE NM -40°C & -5°C
 RANGE NL -40°C & -15°C
 RANGE B -60°C & -25°C

Laser-welded power element in stainless steel
- longer diaphragm life
- high pressure tolerance and working pressure
- high corrosion resistance

To ensure long operating life, the valve cone and seat are made of a special alloy with particularly good wear qualities.

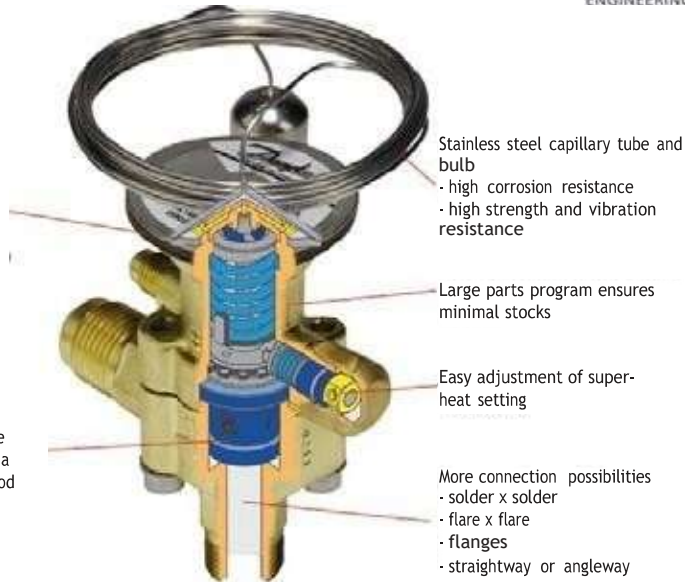

TE5 - TE12 - TE20 - TE55 THERMOSTATIC EXPANSION VALVES

R404A / R507

Model	Range N	Pac.	Price	Range NM Mop 0°C	Pac.	Price	Range NL Mop -10°C	Pac.	Price	Range B Mop -20°C	Pac.	Price
TES 5	067B3342	12	108,74 €	067B3357	12	108,74 €	067B3358	12	108,74 €	067B3343	12	108,74 €
TES 12	067B3347	9	131,74 €	067B3345	9	131,74 €	067B3348	9	131,74 €	067B3349	9	146,38 €
TES 20	067B3352	9	250,93 €	067B3351	9	250,93 €	067B3353	9	250,93 €	067B3354	9	250,93 €
TES 55	067G3302	9	309,48 €	067G3303	9	309,48 €	067G3304	9	309,48 €	067G3305	9	309,48 €

R22

Model	Range N	Pac.	Price	Range NM Mop 0°C	Pac.	Price	Range NL Mop -10°C	Pac.	Price	Range B Mop -20°C	Pac.	Price
TEX 5	067B3250	12	108,74 €	067B3249	12	108,74 €	067B3253	12	108,74 €	067B3251	12	108,74 €
TEX 12	067B3210	9	146,38 €	067B3207	9	146,38 €	067B3213	9	146,38 €	067B3211	9	146,38 €
TEX 20	067B3274	9	250,93 €	067B3273	9	250,93 €	067B3275	9	250,93 €	067B3276	9	250,93 €
TEX 55	067G3205	9	309,48 €	067G3206	9	309,48 €	-	-	-	067G3207	9	309,48 €

R134a

Model	Range N	Pac.	Price	Range NM Mop 0°C	Pac.	Price
TEN 5	067B3297	12	108,74 €	067B3360	12	108,74 €
TEN 12	067B3232	9	131,74 €	-	-	-
TEN 20	067B3292	9	250,93 €	-	-	-
TEN 55	067G3222	9	309,48 €	-	-	-

RANGE N -40°C & +10°C
RANGE NM -40°C & -5°C
RANGE NL -40°C & -15°C
RANGE B -60°C & -25°C

R448A/R449A

Model	Range N	Pac.	Price	Range NL Mop -10°C	Pac.	Price
TE 5	067B3252	12	125,04 €	067B3376	12	106,61 €
TE 12	067B2512	9	160,48 €	067B3377	9	157,35 €
TE 20	067B3294	9	288,57 €	-	-	-
TE 55	067G3219	9	309,49 €	-	-	-

R407C

Model	Range N	Pac.	Price	Range NM Mop +15°C	Pac.	Price
TEZ 5	067B3278	12	108,74 €	067B3277	12	108,74 €
TEZ 12	067B3366	9	131,74 €	067B3367	9	131,74 €
TEZ 20	067B3371	9	250,93 €	067B3372	9	250,93 €
TEZ 55	067G3240	9	309,48 €	067G3241	9	309,48 €

ORIFICE

Type	Code No	R134a		R404A		R407C		R22		R448A/R449A		Orif. No	Pac. Amou.	Price
		Kw	TR	Kw	TR	Kw	TR	Kw	TR	Kw	TR			
TE5 - 0,5	067B2788	5	1,5	7	2	11	3	9	2,5	9	2,5	0,5	8	41,83 €
TE5 - 1	067B2789	11	3	14	4	18	5	16	4,5	18	5	1	8	41,83 €
TE5 - 2	067B2790	14	4,5	19	5,5	25	7	25	7	25	7	2	8	41,83 €
TE5 - 3	067B2791	18	6	25	7	32	9	32	9	32	9	3	8	41,83 €
TE5 - 4	067B2792	25	8	35	10	46	13	42	12	46	13	4	8	41,83 €
TE12 - 5	067B2708	35	10	49	14	53	15	56	16	53	15	5	8	50,19 €
TE12 - 6	067B2709	49	14	63	18	74	21	74	21	70	20	6	8	50,19 €
TE12 - 7	067B2710	63	18	81	23	91	26	95	27	91	26	7	8	50,19 €
TE20 - 8	067B2771	77	22	84	24	116	33	127	36	123	35	8	8	89,93 €
TE20 - 9	067B2773	91	26	102	29	136	38	148	42	141	40	9	8	89,93 €
TE55 - 9B	067G2705	74	21	84	24	109	31	113	32	113	32	9B	8	120,25 €
TE55 - 10	067G2701	109	31	127	36	162	46	169	48	155	44	10	8	120,25 €
TE55 - 11	067G2704	120	34	137	39	176	50	183	52	169	48	11	8	120,25 €
TE55 - 12	067G2707	134	38	151	43	190	54	200	57	186	53	12	8	120,25 €
TE55 - 13	067G2710	165	47	183	52	232	66	246	70	225	64	13	8	120,25 €

Evaporation Temperature +4,4°C, Condensation Temperature +38°C

FLANGE

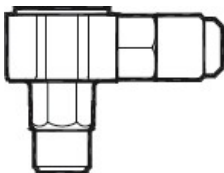
Type	Connection	Threaded	Price	Welded 90°C	Pack. Amou.	Price	Welded Str.	Price
TE 5	1/2" x 5/8"	067B4013	35,55 €	067B4009	32	35,55 €	067B4007	35,55 €
	1/2" x 7/8"			067B4010	32	35,55 €	067B4008	35,55 €
	5/8" x 7/8"			067B4011	32	35,55 €	067B4032	35,55 €
	7/8" x 11/8"			067B4034	32	35,55 €	067B4033	35,55 €
TE 12	7/8" X 11/8"			067B4023	32	38,69 €	067B4021	38,69 €
TE 20	7/8" X 11/8"			067B4023	32	38,69 €	067B4021	38,69 €
TE 55	11/8" X 1 3/8"			067G4004	32	49,15 €	067G4003	49,15 €



Thermostatic Element

+

Orifice

+

Flange

EXPANSION VALVES WITH FIXED ORIFICE

Model	Code No	Capacity		Refr.	Connection	Pack. Amou.	Price
		Kw	TR				
TGES 10-4	067N6172	9	2,6	Oper. Range +10°C -40°C R404A R507	1/2" x 7/8"	12	106,65 €
TGES 10-6	067N6151	14	4		1/2" x 7/8"	12	115,01 €
TGES 10-8	067N6166	18	5		1/2" x 7/8"	12	125,47 €
TGES 10-11	067N6154	26	7,5		5/8" x 7/8"	12	135,93 €
TGES 20-12,5	067N6158	31	9		5/8" x 7/8"	8	177,74 €
TGES 20-16	067N6181	39	11		7/8" x 1 1/8"	8	214,33 €
TGES 20-20	067N6162	45	13		7/8" x 1 1/8"	8	230,03 €
TGES 40-26	067N6161	64	18		7/8" x 1 3/8"	6	292,76 €

Model	Code No	Capacity		Refr.	Connection	Pack Amou.	Price
		Kw	TR				
TGEN 10-3	067N5151	6	1,5	Oper. Range +10°C -40°C R134A	1/2" x 5/8"	12	135,93 €
TGEN 10-4	067N5252	8	2,5		1/2" x 5/8"	12	146,38 €
TGEN 10-6	067N5153	12	3,5		1/2" x 5/8"	12	156,83 €
TGEN 10-8	067N5156	17	4,5		1/2" x 5/8"	12	162,07 €
TGEN 10-11	067N5157	24	7		5/8" x 7/8"	12	167,29 €
TGEN 20-12,5	067N5159	29	8		5/8" x 7/8"	8	188,21 €
TGEN 20-16	067N5161	37	10		5/8" x 1 1/8"	8	209,11 €
TGEN 20-20	067N5163	44	12		7/8" x 1 1/8"	8	230,03 €
TGEN 40-26	067N5165	61	17		7/8" x 1 3/8"	6	292,76 €
TGEN 40-30	067N5255	70	20		1 1/8" x 1 1/8"	6	334,58 €
TGEN 40-40	067N5169	87	25		1 1/8" x 1 3/8"	6	355,48 €



EXPANSION VALVES WITH FIXED ORIFICE

Model	Code No	Capacity		Refr.	Connection	Pack. Amou.	Price
		Kw	TR				
TGEZ 10-3	067N4151	9	2,5	Oper. Range +10°C -40°C R407C	1/2" x 5/8"	12	100,37 €
TGEZ 10-4	067N4002 / 067N4152	13	3,5		1/2" x 7/8"	12	106,65 €
TGEZ 10-6	067N4154	19	5		1/2" x 7/8"	12	115,00 €
TGEZ 10-8	067N4156	25	7		5/8" x 7/8"	12	125,47 €
TGEZ 10-11	067N4157	36	10		5/8" x 7/8"	12	135,93 €
TGEZ 20-12,5	067N4159	42	12		5/8" x 7/8"	8	188,21 €
TGEZ 20-16	067N4162	53	15		7/8" x 1 1/8"	8	214,33 €
TGEZ 20-20	067N4163	62	18		7/8" x 1 1/8"	8	230,03 €
TGEZ 40-26	067N4165	84	24		7/8" x 1 3/8"	6	292,76 €
TGEZ 40-30	067N4167	95	27		7/8" x 1 3/8"	6	334,58 €
TGEZ 40-40	067N4169	121	34	1 1/8" x 1 3/8"	6	376,40 €	

* Evaporation Temperature +4,4°C, Condensation Temperature +38°C

Model	Code No	Capacity		Refr.	Connection	Pack. Amou.	Price
		Kw	TR				
TGEL 10-3	067N9201	12	3,5	Oper. Range +15°C -30°C R410A	1/2" x 5/8"	12	106,65 €
TGEL 10-4	067N9202	16	4,5		1/2" x 7/8"	12	115,01 €
TGEL 10-6	067N9200	24	6,5		5/8" x 7/8"	12	125,47 €
TGEL 10-8	067N9206	32	9		5/8" x 7/8"	12	125,47 €
TGEL 10-11	067N9207	45	13		5/8" x 7/8"	12	135,93 €
TGEL 20-12,5	067N9209	54	15		5/8" x 7/8"	8	188,21 €
TGEL 20-16	067N9212	68	19		7/8" x 1 1/8"	8	214,33 €
TGEL 20-20	067N9213	79	23		7/8" x 1 1/8"	8	230,03 €
TGEL 40-26	067N9285	110	31		7/8" x 1 1/8"	6	292,76 €
TGEL 40-30	067N9218	125	35		1 1/8" x 1 3/8"	6	334,58 €
TGEL 40-40	067N9219	161	46	1 1/8" x 1 3/8"	6	376,40 €	

Evaporation Temperature +4,4°C, Condensation Temperature +38°C



TUAE BI-DIRECTIONAL EXPANSION VALVE R410A

Model	Code No	Oper. Range	Refr.	Connection	Pack. Amou.	Price
TUAE	068U1714	+10°C / -40°C	R410A	3/8" x 1/2"	24	67,10 €

Orifice	Code No	Kw	TR	Price
No: 00	068U1030	0,99	0,28	17,42 €
No: 01	068U1031	1,3	0,38	
No: 02	068U1032	1,7	0,48	
No: 03	068U1033	2,1	0,6	
No: 04	068U1034	4,1	1,2	
No: 05	068U1035	5,3	1,5	
No: 06	068U1036	8,5	2,4	
No: 07	068U1037	11,2	3,2	
No: 08	068U1038	15,8	4,5	
No: 09	068U1039	23,1	6,6	



OIL SEPARATOR

Model	Code No	Conne.	Pack Amou.	Price
OUB 1	040B0010 + 2 X 040B0140	3/8"	4	200,74 €
	040B0010 + 2 X 040B0142	1/2"	4	202,52 €
	040B0010 + 2 X 040B0144	5/8"	4	206,10 €
OUB 4	040B0040 + 2 X 040B0266	5/8"	1	373,05 €
	040B0040 + 2 X 040B0258	3/4"	1	381,95 €
	040B0040 + 2 X 040B0264	7/8"	1	378,39 €
	040B0040 + 2 X 040B0265	1 1/8"	1	390,81 €



HEAT EXCHANGER

Model	Code No	Connec.			Pack. Amou.	Price
		Liq. Line	Suct. Line			
HE 0.5	015D0002	1/4"	1/2"		18	142,12 €
HE 1.0	015D0004	3/8"	5/8"		18	159,87 €
HE 1.5	015D0006	1/2"	3/4"		12	174,10 €
HE 4.0	015D0008	1/2"	1 1/8"		10	219,39 €
HE 8.0	015D0010	5/8"	1 5/8"	10	349,95 €	

SUCTION FILTER

Model	Code No	Connection		Pack. Amou.	Price
DAS 164	023Z1009	1/2"		12	27,33 €
DAS 165	023Z1010	5/8"		12	27,33 €
DAS 166	023Z1011	3/4"		12	27,33 €
DAS 167	023Z1012	7/8"		12	27,33 €
DAS 305	023Z1013	5/8"		8	38,44 €
DAS 306	023Z1014	3/4"		8	38,44 €
DAS 307	023Z1015	7/8"		8	38,44 €
DAS 309	023Z1016	1 1/8"		8	38,44 €
DAS 417	023Z1017	7/8"		8	45,27 €
DAS 419	023Z1018	1 1/8"	8	45,27 €	



THREADED DRIERS

Model	Code No	Connection		Pack. Amou.	Price
DML 032	023Z5035	1/4"		32	6,83 €
DML 033	023Z5036	3/8"		32	6,83 €
DML 052	023Z5037	1/4"		24	8,55 €
DML 053	023Z5038	3/8"		24	8,55 €
DML 083	023Z5040	3/8"		24	10,25 €
DML 084	023Z5041	1/2"		24	10,25 €
DML 163	023Z5043	3/8"		12	12,81 €
DML 164	023Z5044	1/2"		12	12,81 €
DML 165	023Z5045	5/8"		12	12,81 €
DML 166	023Z5046	3/4"		12	12,81 €
DML 303	023Z0049	3/8"		8	22,22 €
DML 304	023Z0050	1/2"		8	22,22 €
DML 305	023Z0051	5/8"		8	22,22 €
DML 306	023Z0193	3/4"		8	22,22 €
DML 415	023Z0110	5/8"	8	44,42 €	

CARTRIDGE DRIER

Model	Code No	Description		Pack. Amou.	Price
48-DC	023U4381	Cartridge Drier		8	17,09 €
48-DA	023U5381	Cartridge Drier (burn)		8	41,00 €
48-F	023U1921	Cartridge Filter	8	34,17 €	

CARTRIDGE CASES

Model	Code No	Connec.	Cartr. Drier		Pack. Amou.	Price
DCR 0485S	023U7250	5/8"	1		1	122,16 €
DCR 0487S	023U7251	7/8"			1	122,16 €
DCR 0489S	023U7253	1 1/8"			1	129,84 €
DCR 04811S	023U7254	1 3/8"	2		1	129,84 €
DCR 09611S	023U7261	1 3/8"			1	130,69 €
DCR 09613S	023U7263	1 5/8"	3		1	130,69 €
DCR 14413S	023U7269	1 5/8"			1	167,43 €
DCR 14417S	023U7270	2 1/8"		1	191,35 €	

WELDED DRIERS

Model	Code No	Connection		Pack. Amou.	Price
DML 032S	023Z4552	1/4"		32	6,83 €
DML 033S	023Z4555	3/8"		32	6,83 €
DML 052S	023Z4559	1/4"		24	8,55 €
DML 053S	023Z4562	3/8"		24	8,55 €
DML 083S	023Z4570	3/8"		24	10,25 €
DML 084S	023Z4572	1/2"		24	10,25 €
DML 163S	023Z4578	3/8"		12	12,81 €
DML 164S	023Z4580	1/2"		12	12,81 €
DML 165S	023Z4581	5/8"		12	12,81 €
DML 304S	023Z4587	1/2"		8	22,22 €
DML 305S	023Z4588	5/8"		8	22,22 €
DML 306S	023Z4589	3/4"		8	22,22 €
DML 307S	023Z4590	7/8"		8	22,22 €
DML 415S	023Z4595	5/8"		8	39,30 €
DML 417S	023Z4596	7/8"		8	39,30 €
DML 757S	023Z4605	7/8"		12	61,50 €
DML 759S	023Z4607	1 1/8"	12	73,47 €	

BI-DIRECTIONAL DRIERS

Model	Code No	Connection		Pack. Amou.	Price
DMB 082S	023Z1443	1/4"		24	18,26 €
DMB 083S	023Z1442	3/8"		24	18,26 €
DMB 084S	023Z1441	1/2"		24	18,26 €
DMB 163S	023Z1476	3/8"		12	18,80 €
DMB 164S	023Z1475	1/2"		12	18,80 €
DMB 165S	023Z1474	5/8"		12	18,80 €
DMB 305S	023Z1478	5/8"		8	32,46 €
DMB 307S	023Z1477	7/8"		8	32,46 €
DMB 309S	023Z1493	1 1/8"		8	44,42 €

THREADED SOLENOID VALVES

Model	Code No	EVRest New Code	Connect.		Pack. Amou.	Price
EVR 3	032F8107	032F8107	1/4"		24	29,90 €
EVR 3	032F8116	032F8116	3/8"		24	29,90 €
EVR 6	032F8079	032L8079	1/2"		12	43,56 €
EVR 10	032F8098	032L8098	5/8"		12	59,80 €

* Coil is not included in the prices.

* Operating range -40°C / +105°C

COILS

Model	Voltage	Code No	Pack. Amou.	Price
BE230CS COIL 17W IP20	220/230V 50 / 60Hz	018F6193	50	17,42 €
BE230CS COIL 17W IP67		018F6732	32	29,63 €
BE230AS COIL 12W IP67	220/230V 50Hz	018F6251	24	26,14 €
BE230AS COIL 12W IP20	220/230V 50Hz	018F6176	50	17,42 €
BE230AS COIL 12W IP67 (Terminal Box)	220V 50Hz	018F6701	32	26,14 €
BE110CS COIL 15W IP67 (Terminal Box)	110V 50-60Hz	018F6730	32	26,14 €
BE440CS COIL 13W IP67	380V 50Hz	018F6703	32	26,14 €
BG012DS COIL 20W IP67 (Terminal Box)	12V DC	018F6856	24	29,63 €
BG024DS COIL 16W IP67 (Terminal Box)	24V DC	018F6857	24	29,63 €
BE024AS COIL 12W IP67	24V AC	018F6707	32	26,14 €







WELDED SOLENOID VALVES

Model	Code No	EVRest New Code	Connect.		Pack. Amou.	Price
EVR 2	032F1201	032F1201	1/4"		24	27,33 €
EVR 3	032F1206	032F1206	1/4"		24	29,90 €
EVR 3	032F1204	032F1204	3/8"		24	29,90 €
EVR 6	032F1212	032L1212	3/8"		12	43,56 €
EVR 6	032F1209	032L1209	1/2"		12	43,56 €
EVR 10	032F1217	032L1217	1/2"		12	59,80 €
EVR 10	032F1214	032L1214	5/8"		12	59,80 €
EVR 15	032F1228	032L1228	5/8"		9	99,09 €
EVR 15	032F1225	032L1225	7/8"		9	99,09 €
EVR 20	032F1240	032L1240	7/8"		6	142,66 €
EVR 20	032F1244	032L1244	1 1/8"	6	148,64 €	
EVR 22	032F3267	032L3267	1 3/8"		6	203,30 €
EVR 25	032F2201	032L2201	1 1/8"		6	252,84 €
EVR 25	032F2208	032L2208	1 3/8"		6	252,84 €
EVR 32	042H1106	032L1106	1 3/8"		1	371,58 €
EVR 32	042H1104	032L1104	1 5/8"		1	371,58 €
EVR 40	042H1110	032L1110	1 5/8"		1	437,36 €
EVR 40	042H1112	032L1112	2 1/8"		1	437,36 €

*Coil is not included in the prices.

* Operating range -40°C / +105°C

PRESSURE REGULATORS

Model	Code No	Connect.	Evaporator Pressure Regulators	Pack. Amou.	Price
KVP 12	034L0023	1/2"		12	112,40 €
KVP 15	034L0029	5/8"		12	112,40 €
KVP 22	034L0025	7/8"		12	174,25 €
KVP 28	034L0026	1 1/8"		7	260,51 €
KVP 35	034L0032	1 3/8"		7	278,82 €
Model	Code No	Connect.	Crankcase Pressure Regulators	Pack. Amou.	Price
KVL 12	034L0043	1/2"		12	93,23 €
KVL 15	034L0049	5/8"		12	93,23 €
KVL 22	034L0045	7/8"		12	145,51 €
KVL 28	034L0046	1 1/8"		7	216,07 €
KVL 35	034L0052	1 3/8"		7	223,93 €
Model	Code No	Connect.	Condenser Pressure Regulators	Pack. Amou.	Price
KVR 12	034L0093	1/2"		12	139,40 €
KVR 15	034L0097	5/8"		12	156,83 €
KVR 22	034L0094	7/8"		12	174,25 €
KVR 28	034L0095	1 1/8"		7	278,82 €
KVR 35	034L0100	1 3/8"		7	272,72 €
Model	Code No	Connect.	Capacity Regulator	Pack. Amou.	Price
KVC 12	034L0143	1/2"		12	105,43 €
KVC 15	034L0147	5/8"		12	108,91 €
KVC 22	034L0144	7/8"		12	180,36 €
Model	Code No	Connect.	Hot Gas Bypass Regulator	Pack. Amou.	Price
CPCE 12	034N0082	1/2"		8	246,58 €
CPCE 15	034N0083	5/8"		8	257,04 €
CPCE 22	034N0084	7/8"		8	413,87 €
Model	Code No	Connect.	Check Valve	Pack. Amou.	Price
NRD12s	020B1132	1/2"		24	81,55 €

* KVR pressure regulator is must be used with NRD check valve.

WELDED SIGHT GLASSES

Model	Code No	Connect.	 <p style="text-align: center;">35 Bar / 500 psi / -50°C / +80°C</p>			Pack. Amou.	Price
SGN 6S	014-0181	1/4"				25	10,25 €
SGN 10S	014-0182	3/8"				25	11,11 €
SGN 12S	014-0183	1/2"				28	12,81 €
SGN 16S	014-0184	5/8"				28	17,09 €
SGN 19S	014-0185	3/4"				28	23,92 €
SGN 22S	014-0186	7/8"				28	29,90 €
SGN 22S	014-0187	1 1/8"				<div style="display: flex; align-items: center; gap: 10px;"> <div style="width: 20px; height: 20px; background-color: green;"></div> DRY <div style="width: 20px; height: 20px; background-color: yellow;"></div> MOISTURE </div>	28

Model	Code No	Connect.	 <p style="text-align: center;">52 Bar / 754 psi / -50°C / +80°C</p>			Pack. Amou.	Price
SGP 6s N	014L0181	1/4"				25	13,67 €
SGP 10s N	014L0182	3/8"				25	15,08 €
SGP 12s N	014L0183	1/2"				28	18,80 €
SGP 16s N	014L0184	5/8"				28	25,63 €
SGP 19s N	014L0185	3/4"				28	30,76 €
SGP 22s N	014L0186	7/8"				28	35,88 €
SGP 22s N	014L0187	1 1/8"				<div style="display: flex; align-items: center; gap: 10px;"> <div style="width: 20px; height: 20px; background-color: green;"></div> DRY <div style="width: 20px; height: 20px; background-color: yellow;"></div> MOISTURE </div>	28

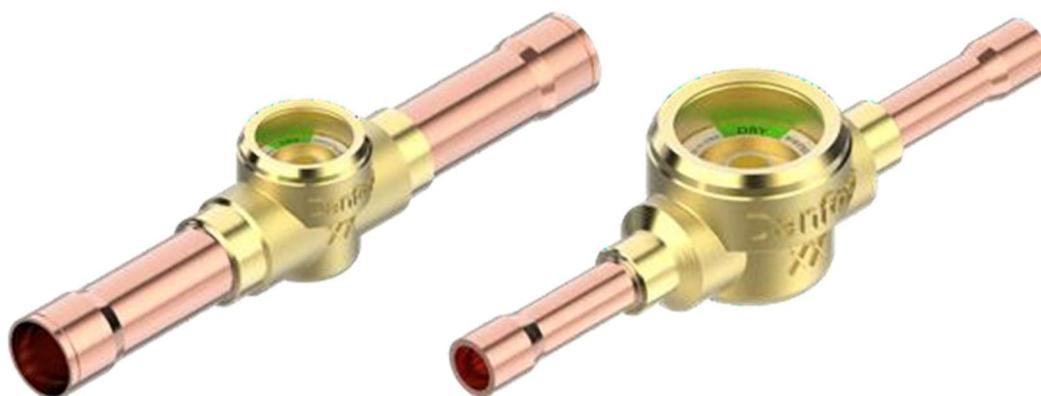

BALL VALVES

Model	Code No	New Code	Connect.		Pack. Amou.	Price
GBC 6S	009G7050	009L7050	1/4"		25	20,51 €
GBC 10S	009G7051	009L7051	3/8"		25	22,56 €
GBC 12S	009G7052	009L7052	1/2"		25	24,60 €
GBC 16S	009G7053	009L7053	5/8"		25	26,65 €
GBC 18S	009G7054	009L7054	3/4"		25	36,90 €
GBC 22S	009G7055	009L7055	7/8"		25	41,00 €
GBC 28S	009G7056	009L7056	1 1/8"		5	61,50 €
GBC 35S	009G7057	009L7057	1 3/8"		5	123,01 €
GBC 42S	009G7058	009L7058	1 5/8"		4	184,50 €
GBC 54S	009G7059	009L7059	2 1/8"		2	328,02 €
GBC 67S	009G7960	009L7960	2 5/8"		1	742,14 €
GBC 79S	009G7981	009L7981	3 1/8"		1	1.010,69 €

1/4" Service Port with Valve

WATER REGULATOR VALVES

Model	Code No	Connection			Pack. Amou.	Price
		Water Inlet	Bar	Condenser Connection Size		
WVFX 10	003N1105	3/8"	4,0 - 23		10	89,75 €
WVFX 15	003N2105	1/2"			10	96,72 €
WVFX 20	003N3100	3/4"			10	136,80 €
WVFX 25	003N4105	1"			10	155,09 €
WVFX 32	003F1232	1 1/4"	4,0 - 17		4	263,13 €
WVFX 40	003F1240	1 1/2"			4	277,95 €

1/4" in. / 6mm flare

CHECK VALVES

Model	Code No	Connect.		Pack. Amou.	Price
NRV 6	020-1040	1/4"		25	12,55 €
NRV 10	020-1041	3/8"		25	14,64 €
NRV 12	020-1042	1/2"		25	15,69 €
NRV 16	020-1043	5/8"		25	18,82 €
NRV 19	020-1044	3/4"		24	28,22 €

Model	Code No	Connect.		Pack. Amou.	Price
NRV 6S	020-1010	1/4"		25	12,55 €
NRV 10S	020-1011	3/8"		25	14,64 €
NRV 12S	020-1012	1/2"		24	15,69 €
NRV 16S	020-1018	5/8"		24	18,82 €
NRV 19S	020-1019	3/4"		28	28,22 €
NRV 19S	020-1054	7/8"	28	28,22 €	

Model	Code No	Connect.		Pack. Amou.	Price
NRV 22S	020-1020	7/8"		18	36,59 €
NRV 22S	020-1060	1 1/8"		18	51,24 €
NRV 28S	020-1021	1 1/8"		6	77,37 €
NRV 35S	020-1026	1 3/8"		6	92,01 €
NRV 35S	020-1061	1 5/8"	6	92,01 €	

* Working pressure is 46 bar.

4 WAY SOLENOID VALVES

Model	Code No	Capacity		Connection	Pack. Amou.	Price
		R407C	R410A			
STF-0201G3	061L1144	10.11 kw	12,43 kw	3/8" - 1/2"	32	31,81 €
STF-0301G3	061L1194	12.29 kW	15.08 kW	1/2" - 5/8"	32	37,67 €
STF-0306G3	061L1151	12.29 kW	15.08 kW	1/2" - 3/4"	32	37,85 €
STF-0401G3	061L1152	22.40 kW	27.51 kW	1/2" - 3/4"	24	67,69 €
STF-0712G3	061L1195	38.05 kW	46.74 kW	3/4" - 7/8"	6	107,82 €
STF-1511G3	061L1224	42.39 kW	52.05 kW	7/8" - 1 1/8"	1	206,28 €
STF-2011G3	061L1219	54.18 kW	66.55 kW	7/8" - 1 1/8"	1	211,06 €
STF-2505G3	061L1279	81.89 kW	100.56 kW	1 1/8" - 1 3/8"	1	366,71 €
STF-3003G3	061L1282	115.61 kW	141.98 kW	1 1/8" - 1 5/8"	1	508,00 €
STF-4001G3	061L1284	161.37 kW	198.18 kW	1 1/2" - 1 3/4"	1	641,62 €
STF-5002G3	061L1287	209.54 kW	246.98 kW	1 5/8" - 2 1/8"	1	1.141,56 €
VHV-6001	061L1186	333.56 kW	413.77 kW	1 5/8" - 2 5/8"	1	3.749,93 €
STF-01AJ512D1	061L2074	Coil 220-240V 6 Watt 2 mt cable IP54			60	11,21 €
STF-01AB503B1	061L2038	Coil 24V 6 Watt 2 mt cable IP100			100	14,23 €

* Coil is not included in 4 Way valve prices.

PHASE SPEED CONTROL MODULES

Model	Code No	Oper. Range	Factory Set Value	Nominal Amps	Voltage	Pack. Amou.	Price
XGE-4CI	061H3141	10-25 bar	19 bar	0,2~3 Amp.	220 V	60	75,70 €
RGE-Z1N4-7DS	061H3005	8-28 bar	19 bar	0,2~4 Amp.	220 V	20	180,52 €
RGE-Z1P4-7DS	061H3008	8-28 bar	19 bar	0,2~6 Amp.	220 V	16	233,73 €
RGE-Z1Q4-7DS	061H3009	8-28 bar	19 bar	0,2~8 Amp.	220 V	16	277,54 €
RGE-X3R4-7DS	061H3006	8-28 bar	16 bar	0,2~5 Amp.	380 V	6	693,07 €
RGE-Z1N6-7DS	061H3021	16-39 bar	32 bar	0,2~4 Amp.	220 V	20	182,09 €
RGE-Z1P6-7DS	061H3022	16-39 bar	32 bar	0,2~6 Amp.	220 V	16	244,32 €
RGE-Z1Q6-7DS	061H3023	16-39 bar	32 bar	0,2~8 Amp.	220 V	16	284,23 €
RGE-X3R6-7DS	061H3028	16-39 bar	32 bar	0,2~5 Amp.	380 V	6	722,10 €

* 1/4" female connection



WENTO AXIAL FANS - BLOWING

Model	RPM	Current (A)	Power (Watt)	Air Flow (m ³ /h)	Voltage 50 Hz	Price
RFC4-020-YLB	1.460 d/dk	0,12	29	490	230	31,60 \$
RFC4-025-YLB	1.380 d/dk	0,22	50	1.000	230	33,60 \$
RFC4-030-YLB	1.370 d/dk	0,38	90	1.900	230	36,10 \$
RFC4-035-YLB	1.370 d/dk	0,68	138	2.980	230	48,20 \$
RFC4-040-YLB	1.350 d/dk	0,81	180	3.700	230	53,20 \$
RFC4-045-YLB	1.380 d/dk	1,15	250	4.800	230	60,20 \$
RFC4-050-YLB	1.320 d/dk	1,85	420	6.950	230	79,35 \$

WENTO AXIAL FANS – SUCTION (STAINLESS)

Model	RPM	Current (A)	Power (Watt)	Air Flow (m ³ /h)	Voltage 50 Hz	Price
RFC4-045-XLB	1.380	1,15	250	4.800	230	228,90 \$
RFC4-050-XLB	1.320	1,85	420	6.950	230	307,65 \$

WENTO AXIAL FANS - 7 BLADES

Model	RPM	Current (A)	Power (Watt)	Air Flow (m ³ /h)	Voltage 50 Hz	Price
RFC4-050-XLB-7b	1.400	1,85	420	7.000	230	102,75 \$
RFC4-050-YLB-7b						102,75 \$



WENTO PLUG FANS WITH EXTERNAL ROTOR MOTOR

Model	Blade Diam. Ø (mm)	Watt (W)	RPM	Air Flow (m ³ /h)	Voltage	Price
2E175-GH	175	60	2.610	505	220V	36,50 \$
2E192-GH	192	70	2.450	540		35,77 \$
2E225-GH	225	150	2.600	1.040		47,50 \$
2E250-GH	250	200	2.600	1.450		54,85 \$
2E280-GH	280	250	2.500	1.750		79,75 \$
4E310-GH	310	140	1.370	1.650		95,90 \$
4E355-GH-2	355	220	1.360	2.451		109,75 \$
4E400-GH	400	560	1.350	4.100		177,75 \$
4E450-GH	450	830	1.340	5.600		226,65 \$
4E500-GH	500	1550	1.380	7.600		374,50 \$

4D400-GH	400	560	1.350	4.050	380V	172,75 \$
4D500-GH	500	1560	1.330	7.400		334,50 \$

* Suction Mouth Plastering is INCLUDED in the Prices.



WENTO AXIAL FANS – SUCTION

Model	RPM	Current (A)	Power (Watt)	Air Flow (m³/h)	Voltage 50 Hz	Price
RFC4-020-XLB	1.460	0,12	29	490	230	29,50 \$
RFC4-025-XLB	1.380	0,22	50	1.000	230	31,50 \$
RFC4-030-XLB	1.370	0,38	90	1.900	230	33,90 \$
RFC4-035-XLB	1.370	0,68	138	2.980	230	45,20 \$
RFC6-035-XLB	930	0,4	80	2.100	230	48,25 \$
RFC4-040-XLB	1.350	0,81	180	3.700	230	49,95 \$
RFC6-040-XLB	940	0,67	115	2.800	230	53,20 \$
RFCT4-040-XLB	1.380	0,48	190	3.900	380	53,20 \$
RFC4-045-XLB	1.380	1,15	250	5.100	230	56,30 \$
RFC6-045-XLB	950	0,6	120	3.100	230	60,20 \$
RFCT4-045-XLB	1.380	0,58	250	5.100	380	60,20 \$
RFC4-050-XLB	1.320	1,85	420	6.950	230	74,50 \$
RFC6-050-XLB	920	1,15	230	5.200	230	79,35 \$
RFGT4-050-XLB	1.320	0,93	450	7.000	380	79,35 \$
RFGC6-063-XLB	930	2,2	500	9.600	230	130,90 \$
RFGT6-063-XLB	920	1,57	550	9.580	380	130,90 \$
RFCT4-063-XLB	1.365	1,95	860	13.000	380	138,75 \$
* RFGT4-063XQ	1.350	3,5	1.900	15.300	400 Volt Δ/Y	474,20 \$
	1.050	2,3	1.400	11.900		
* RFGT6-071XQ	900	2,35	1.100	15.800		498,40 \$
	1.050	1,2	700	13.500		
* RFGT6-080XQ	880	3,65	1.650	20.800		506,92 \$
	700	1,94	1.060	15.600		
* RFGT6-091XQ	870	4,7	2.450	25.500		699,70 \$
	670	2,6	1.550	21.000		

* Model with hood.

CUOGHI DEHUMIDIFIER

Model	Specifications	Price
F7115W	NADER MIDI 3DL EG2 RAL 9006 (PURE WHITE) 4 Lt. Liquid Tank - Electronic Float - Electronic Humidity Meter - Air Filter - Automatic Defrost System - Volume: 250m3 - Working Conditions: +5°C...+32°C, 35... 100%R.H. - Capacity: 18,6 L/24 H at 30°C, 80%R.H. - 230 V, 50 Hz	952,30 €
F7101	NADER MIDI 4 EG 6 Lt. Liquid Tank - Electronic Float - Electronic Humidity Meter - Air Filter - Automatic Defrost System - Volume: 400 m3 - Working Conditions: +5°C...+32°C, 35... 100%R.H. - Capacity: 28 L/24 H at 30°C, 80%R.H. - 230 V, 50 Hz	1.155,60 €
F7114	NADER EG2 12 Lt. Liquid Tank - Electronic Float - Electronic Humidity Meter - Air Filter - Hot Gas Defrost - Volume: 600 m3 - Working Conditions: +2°C...+32°C, 35... 100%R.H. - Capacity: 54 L/24 H at 30°C, 80%R.H. - 230 V, 50 Hz	1.926,00 €
F7112	NADER YARD PRO EG - Industrial Buildings - Electronic Control Panel - Timer - Electronic Humidity Meter - Air Filter - Hot Gas Defrost Volume: 800 m3 - Working Conditions: +2°C...+32°C, 35... 100%R.H. - Capacity: 81 L/24 H at 30°C, 80%R.H. - 230 V, 50 Hz	3.204,65 €

The NADER midi series is designed for museums, warehouses, rooms and all situations where the solution of excessive humidity is a major problem and for the safe protection of valuable materials or buildings from excessive moisture. It is equipped with an electronic control panel that efficiently controls the defrost cycle and a moisture meter that turns the unit on only when necessary; moreover, its special design allows it to be installed in underutilized spaces, such as against a wall or between two pieces of furniture. All units are set for optional continuous water drainage. NADER is also equipped with a hot gas defrosting device that allows efficient dehumidification down to +2oC.



CUOGHI ADIABATIC HUMIDIFIER

Model	Voltaaj	Nemlendirme Kapasitesi (lt/h)	Çalışma Sıcaklığı	Güç Tüketimi (Watt)	Hava Debisi (m ³ /h)	Fiyat
MINI NEB F2075	220V / 50 Hz	1	+1°C - +35°C	23	80	470,80 €
NEB 6500 F2060.2		6,5		220	280	1.064,65 €



NEB 6500



MiniNEB



UCV



AC

NEB 6500 Atc + Control Box F2067	220V / 50 Hz	6,5		220	280	1.588,75 €	
MINI NEB KIT F2037	Mechanical Hygrostat					176,00 €	
UCV 52 F2040.1	3-400V / 50 Hz	Dual Motor, Nebulizing, Free Cooling	35	+1°C - +35°C	510	3400	1.277,80 €
UCV 63/4 F2042.1			35		590	7600	1.352,42 €
AC1-80 F2001			80		320	-	762,77 €
AC2-160 F2002			160		420	-	1.055,96 €

ACCESSORIES

Model	Capacity (lt/h)	Price
MT 530E	Full Gauge Hygrostat - Including humidity sensor	127,90 €
XT110C	Hygrostat, 1 Relay, 4-20MA Signal, Digital Display	98,78 €
XH20P	4-20 ma Signal, 10...99%RH Humidity Sensor	160,52 €
F2061	NEB 6500 Freeze Resistance	93,86 €
F2035	NEB 6500 Control Panel (Hygrostat + Electrical Protection Apparatus)	586,07 €
70008	NEB 6500 Electronic Control Card (Flow Control, Drainage, etc.)	209,92 €

- NEB series humidifiers are designed for cold rooms, warehouses, greenhouses, germination cells/chambers and any application where highly efficient and reliable humidification is required. They are easy to maintain, run on tap water or fully distilled water, have a very small water tank (55 cm³) and an automatic water draining system to follow the most rigorous hygienic rules.

Hygrostat and Humidity Sensor are not included in the price.

- Control Box = Atmospheric control unit developed for Neb 6500Atc Device

STAND ALONE SEUNGIL (HOT STEAM) HUMIDIFIER

Model		Voltage	Capacity (Kg/h)	Steam Output Dim. (Ø / mm)	Power Consump.(Kw)	Price
BH004-6		220V/50Hz	4	22	3	1.236,45 \$
BH004-7		380-480V 50 Hz	4	22	3	1.236,44 \$
BH008-7			8	22	6	1.300,28 \$
BH015-7			15	22	11,3	1.385,37 \$
BH045-7			45	30	33,8	2.451,79 \$
BH030-7			30	22	22,6	Ask for Price
BH060-7			65	45	2 x 33,8	
BH090-7	90		45	3 x 33,8		
	On-Off ve Proportional Control					

* SI-HUMP Control device is included in the price.

* Sensor, distributor and hose are not included in the price.

SPARE PARTS AND ACCESSORIES

Model	Dim. (mm)	Type (Kg/h)		Price
DISTRIBUTOR SNS-230	Ø 22	4 - 6 - 8		60,06 \$
DISTRIBUTOR SNS-350	Ø 30	15		69,30 \$
DISTRIBUTOR SNS-450	Ø 45	45		92,40 \$
CYLINDER C-261		6		192,10 \$
CYLINDER C-383		8		192,97 \$
CYLINDER C-3153		15		231,24 \$
CYLINDER C-3453		45		672,24 \$

OEM TYPE SEUNGIL (HOT STEAM) HUMIDIFIER

Model	Type	Voltage	Capacity (Kg/h)	Steam Output Dim. (Ø / mm)	Power Consump.(Kw)	Price
OH004-6	OEM	220V / 50 Hz	4	22	3	299,85 \$
OH006-7		380 - 480V / 50 Hz	4	22	3	320,80 \$
OH006-6		220V / 50 Hz	6	22	5	320,80 \$
OH008-7		380 - 480V / 50 Hz	8	22	6	320,80 \$
OH015-7		380 - 480V / 50 Hz	15	30	11,3	356,91 \$
OH045-7		380 - 480V / 50 Hz	45	45	33,8	842,11 \$

* EM2 controller, humidity sensor, distributor and steam hose are not included in the price.

Model	Type	Voltage	Capacity (Kg/h)	Steam Output Dim. (Ø / mm)	Power Consump.(Kw)	Price
OH004-6 + EM2	OEM	220V / 50 Hz	4	22	3	459,85 \$
OH006-7 + EM2		380 - 480V / 50 Hz	4	22	3	480,80 \$
OH006-6 + EM2		220V / 50 Hz	6	22	5	480,80 \$
OH008-7 + EM2		380 - 480V / 50 Hz	8	22	6	480,80 \$
OH015-7 + EM2		380 - 480V / 50 Hz	15	30	11,3	516,91 \$
OH045-7 + EM2		380 - 480V / 50 Hz	45	45	33,8	1.002,11 \$

Model	Voltage	Output	Communication	Signal	Water Drain	Price
EM2-B Control Card	24V	Control Relay Alarm Relay	RS-485	4-20mA	Automatic / Manual	320,95 \$
EM2-B Screen	12V DC					355,00 \$

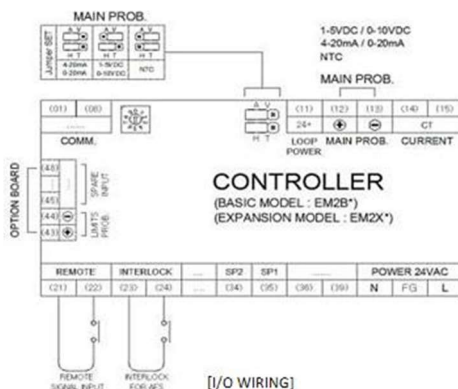

SYSLAB PARAMETRIC CONTROLLERS

Industrial Mini Chiller Controllers

Model				Price
SL1506-ST	Digital Output	5	Single and Double comp. control Four-way valve (Electric heater) Condenser fan control Alarm Output Bypass Valve Internal phase sequence protection Voltage surge protection Direct drive up to 2HP Compressor Built-in Transformer Lcd Display Current control Freeze Protection Function	 SL109S (Screen) Included in the Price.
	Digital Inlet	10		
	Analog Inlet	7		
	Supply	220VAC		
	Connection	RS485×1/SPI×1		
	Size	151mm×94mm		
	Terminal	Euro-plug / Terminal block		
	Current Detector	3 (external)		
	3-Phase Control	On the board		
				100,08\$

Accessories

NTC-10K	4,93 \$
Ampere Control card (1 pc.)	5,58 \$
SYSLAB Transformer 12V 2A	25,00 \$
SYSLAB Transformer 220V-12V 1A	25,00 \$



Fan Controller (Mono Phase)

SL220ME	Operation Voltage	220V±15% 50/60Hz	 IP 65	152,06 \$
	Input Signal Type	Pressure Transducer 0~5 Vdc NTC10K 0-10V External signal		
	Continuous Amps	5A		

Set, differential, sensor type, straight and reverse operation type, min and max settings can be made on the card.

SL220M	Operation Voltage	220V±15% 50/60Hz		89,94 \$
	Input Signal Type	Pressure Transducer 0~5 Vdc NTC10K 0-10V External signal		
	Continuous Amps	5A		

Temperature and Humidity Sensors

SL180W	Operation Voltage	12-24VDC	 CMOSens® Digital Sensing Thechnology	87,86 \$
	Input Signal Type	4-20mA, 0-5V, 0-10V		
	Measurement Range	-20 / 80°C / 10 - 100% RH		
SL180D	Operation Voltage	12-24VDC	 CMOSens® Digital Sensing Thechnology	115,93 \$
	Input Signal Type	4-20mA, 0-5V, 0-10V		
	Measurement Range	-20 / 80°C / 10 - 100% RH		

SYSLAB PARAMETRIC CONTROLLERS

2 Circuits Industrial Chiller Controller

Model	Water cooled - Air-cooled condenser control			Price	
SL1500-CW	Digital Output	8	2 circuit control Total 2 compressors 2 pcs. Four-way valve Condenser fan On/Off control Alarm Output Bypass Valve Internal phase sequence protection Voltage surge protection Lcd Display Flow control Flow switch Frost Protection Function Heater / alarm output Master / Slave mode		256,10 \$
	Digital Inlet	7			
	Analog Inlet	5			
	Analog Outlet	1			
	Supply	12 VAC			
	Connection	RS485 ModBus x 2			
	Size	134.0 mm x 142.0 mm			
	Terminal	Euro-plug/Terminal block			
	3-Phase Control	On the board			

4 Circuit 4 Compressor Industrial Chiller Controller

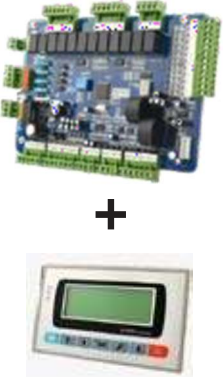
Model	Air cooled condenser (HEAT PUMP)			Price	
SL2600-MO	Digital Output	18	4ad. Compressor 4 pcs. Four-way valve Condenser fan On/Off control 4 pcs. expansion valve driver Alarm Output Built-in phase sequence protection Voltage surge protection Current control Lcd Display Flow swich Frost Protection Function Heater / alarm output Master / Slave mode		510,36 \$
	Digital Inlet	21			
	Analog Inlet	18			
	Analog Outlet	-			
	Supply	12 VAC			
	Connection	RS485 ModBus x 2			
	Size	267,6 mm x 135,0 mm			
	Terminal	Euro-plug/Terminal block			
	3-Phase Control	On the board			

2 Compressor SCREW Industrial Chiller Controller

Model	SCREW Air-cooled condenser control			Price	
SL3600-CW	Digital Output	30	Stepless, 3-stage or 4-stage stepper capacity control 1 ea. Four-way valve Alarm Register Alarm Output Compressor oil pressure Liquid injection Touch Screen Master / Slave mode		770,99 \$
	Digital Inlet	21			
	Analog Inlet	12			
	Analog Outlet	0			
	Supply	12 VAC			
	Connection	RS485 ModBus x 3			
	Size	288 mm x 150.0 mm			
	Terminal	Euro-plug/Terminal block			
	Part-Winding and Star Triangle Output.				

SYSLAB PARAMETRIC CONTROLLERS

2 Compressor Rooftop Controller

Model	Fresh air damper control			Price	
SL1500-PU2	Digital Output	8	Singlecard 2 compressors Total 4 compressors 2 pcs. Four-way valve Total of 4 four-way valves Condenser fan On/Off control Alarm Output Built-in phase sequence protection Voltage surge protection Lcd Display Heater / alarm output Master / Slave mode		242,62 \$
	Digital Inlet	7			
	Analog Inlet	5			
	Analog Outlet	1			
	Supply	12 VAC			
	Connection	RS485 ModBus x 2			
	Size	134.0 mm × 142.0 mm			
	Terminal	Euro-plug/Terminal block			
	3-Phase Control	On the board			

AHU Controller

Model	Differential control, PI control, proportional integrated dehumidification control			Price	
SL1800-AH	Digital Output	5	1ad. Cooling Valve 1ad. Heating Valve 2ad. Heater control Alarm Output LCD display Master / Slave mode		242,62 \$
	Digital Inlet	5			
	Analog Inlet	3			
	Analog Outlet	-			
	Supply	12 VAC			
	Connection	RS485 ModBus x 2			
	Size	125,0 mm × 117,0 mm			
	Terminal	Euro-plug/Terminal block			

2 Compressors, 1 Humidifier and 2 Heaters AHU- AC Controller

Model	Differential control, PI control, proportional integrated dehumidification control			Price	
SL1600F-TH3	Digital Output	12	1ad. Cooling Valve 1ad. Heating Valve 2ad. Heater control Alarm Output LCD display Master / Slave mode		943,50 \$
	Digital Inlet	13			
	Analog Inlet	6			
	Analog Outlet	2			
	Supply	12 VAC			
	Connection	RS485 ModBus x 3			
	Size	288 mm × 150.0 mm			
	Terminal	Euro-plug/Terminal block			

MATCHWELL ELECTRONIC PRESSURE SWITCHES

Model	Application Type	On (Bar)	Off (Bar)	Specifications	Price
V007G026G (Low Pressure)	Auto Reset	1,8	-0,5	1.5 Mt Wired Two Pronged P67 Protected	6,95 \$
004D026G (Low Pressure)	Auto Reset	1,8	0,3		6,95 \$
010F030G (Low Pressure)	Auto Reset	2,1	0,7		6,95 \$
025G040G (Low Pressure)	Auto Reset	2,7	1,7		6,95 \$
025G054G (Low Pressure)	Auto Reset	3,7	1,7		6,95 \$
2,3G3,5G (Low Pressure)	Auto Reset	3,5	2,3		6,95 \$
085M011M (Fan Control)	Auto Reset	11	8,5		6,95 \$
189R261R (Fan Control)	Auto Reset	18	13		6,95 \$
218R276R (Fan Control)	Auto Reset	19	15		6,95 \$
232R305R (Fan Control)	Auto Reset	21	16		6,95 \$
18R21R (Fan Control)	Auto Reset	21	18		6,95 \$
24R29R (Fan Control)	Auto Reset	29	24		6,95 \$
021R016R (High Pressure)	Auto Reset	16	21		6,95 \$
024R018R (High Pressure)	Auto Reset	18	24		6,95 \$
377R290R (High Pressure)	Auto Reset	20	26		6,95 \$
406R305R (High Pressure)	Auto Reset	21	28		6,95 \$
450R377R (High Pressure)	Auto Reset	26	31		6,95 \$
580R464R (High Pressure)	Auto Reset	32	40		6,95 \$
042R033R (High Pressure)	Auto Reset	33	42		6,95 \$

Operating Temperature : -50°C~+120°C

Burst Pressure : 5.000 PSI (345 Bar)

Electric Capacity : (24V = 125Watt) - (120-230V = 375Watt)



MATCHWELL FANCOIL MOTOR

Code	Model	Pack	Price
YF120-140-4A6	Matchwell Fancoil Motor 140 W, 220V, 50 Hz, Double Shaft, 1040/1225/1330 rpm	80	93,00 \$
	FANCOIL BLADE Ø14 cm L. 22,80 cm	-	15,90 \$

WELDED SIGHT GLASSES

Model No	Code No	Connection	Specifications	Pack	Price
SGN-1/4	6001-00	1/4"	<ul style="list-style-type: none"> Precise Color Calibration Full Sealing and Wide Viewing Angle <p style="text-align: center;">45 Bar / 652 psi -40°C / +80°C</p> 	100	5,30 \$
SGN-3/8	6002-000	3/8"		100	7,10 \$
SGN-1/2	6003-00A	1/2"		100	7,65 \$
SGN-5/8	6004-00A	5/8"		100	9,50 \$
SGN-3/4	6005-00A	3/4"		50	11,55 \$
SGN-7/8	6006-00A	7/8"		50	13,90 \$
SGN-1 1/8	6008-00	1 1/8"		40	24,60 \$

THREADED SIGHT GLASSES

Model No	Code No	Connection	Specifications	Pack	Price
SGN-1/4	6011-00A	1/4"	<p style="text-align: center;">35 Bar / 508 psi -40°C / +80°C</p> 	100	4,90 \$
SGN-3/8	6012-00A	3/8"		100	6,30 \$
SGN-1/2	6013-00A	1/2"		100	7,00 \$
SGN-5/8	6014-00A	5/8"		50	9,10 \$



MALE-FEMALE THREADED SIGHT GLASSES

Model No	Code No	Connection	Specifications	Pack	Price
SGN-1/4 MF	6131-00A	1/4"	<p style="text-align: center;">60 Bar / 870 psi -40°C / +80°C</p> 	50	6,45 \$
SGN-3/8 MF	6132-00A	3/8"		50	7,55 \$
SGN-1/2 MF	6133-00A	1/2"		50	8,55 \$
SGN-5/8 MF	6134-00A	5/8"		50	10,60 \$

CHROME BRAIDED ABSORBER

Model No	Code No	Connect.	Maximum Operating Pressure	Specifications	L(cm)	Pack	Price
VAFX-038	7482-30A	3/8"	45 Bar		21	100	9,35 \$
VAFX-012	7483-30A	1/2"	45 Bar		23	100	9,75 \$
VAFX-058	7484-30	5/8"	45 Bar		25	100	11,55 \$
VAFX-034	7485-30	3/4"	45 Bar		26	100	15,60 \$
VAFX-078	7486-30	7/8"	45 Bar		30	100	16,75 \$
VAFX-118	7488-30	1 1/8"	45 Bar		33	50	20,30 \$
VAFX-138	7489-30	1 3/8"	42 Bar		40	30	32,65 \$
VAFX-158	7490-30	1 5/8"	30 Bar		40	20	45,80 \$
VAFX-218	7411-01	2 1/8"	25 Bar		52	10	69,75 \$
VAFX-258	7412-01	2 5/8"	20 Bar		61	6	140,50 \$
VAFX-318	7413-01	3 1/8"	20 Bar		68	4	173,00 \$

HONGSEN EXPANSION VALVE

Refr. Type	Model	Connection			Pack.	Price
		Internal Eq.	3/8" - 1/2"			
R410A	TH410 (ODF)	Internal Eq.	3/8" - 1/2"		45	27,90 \$
	TH410W (ODF)	External Eq.	3/8" - 1/2"		45	28,75 \$
R404A	TH404 (ODF)	Internal Eq.	3/8" - 1/2"		45	26,50 \$
	TH404W (ODF)	External Eq.	3/8" - 1/2"		45	27,75 \$
R404A	TH404	Internal Eq.	3/8" - 1/2"		45	23,90 \$
	TH404W	External Eq.	3/8" - 1/2"		45	24,75 \$
R134A	TH134	Internal Eq.	3/8" - 1/2"		45	23,90 \$
	TH134W	External Eq.	3/8" - 1/2"		45	24,75 \$
R22	TH22	Internal Eq.	3/8" - 1/2"		45	23,90 \$
	TH22W	External Eq.	3/8" - 1/2"		45	24,75 \$

Orifice	Cooling Capacity (TR)				Cooling Capacity (Kw)					Pack.	Price
	R22	R134A	R404A	R410A	R22	R134A	R404A	R410A			
No: 1	0,7	0,5	0,45	0,92	2,5	1,8	1,6	3,25	24	5,20 \$	
No: 2	1	0,8	0,6	1,55	3,5	2,6	2,1	5,45	24		
No: 3	1,5	1,3	1,2	2,5	5,2	4,6	4,2	8,7	24		
No: 4	2,3	1,9	1,7	4	8	6,7	6	14,15	24		
No: 5	3	2,5	2,2	4,9	10,5	8,6	7,7	17,28	24		
No: 6	4,5	3	2,6	5,7	15,5	10,5	9,1	19,95	24		

BALL VALVES

Model No	Code No	Connection	 Operating Temperature -40°C / +150°C Maximum Operating Pressure 45 Bar Hermetic Design Brass Body 1/4" Service Port with Valve	Pack	Price
HBC 6SV	7301-02S	1/4"		50	13,55 \$
HBC 10V	7302-52	3/8"		50	17,15 \$
HBC 12V	7303-52	1/2"		50	17,55 \$
HBC 16V	7304-52	5/8"		50	17,90 \$
HBC 19V	7305-82	3/4"		50	21,90 \$
HBC 22V	7306-52	7/8"		50	25,90 \$
HBC 28V	7307-52	1 1/8"		30	41,00 \$
HBC 35V	7308-52	1 3/8"		10	66,10 \$
HBC 42V	7309-52	1 5/8"		8	96,70 \$
HBC 54V	7310-52	2 1/8"		6	150,50 \$
HBC 67V	7311-52	2 5/8"		6	160,75 \$
HBC 79V	7312-52	3 1/8"		6	169,90 \$

THREADED DRIERS

Model No	Connection	Specifications	Pack	Price
DFS 032	1/4"	Up to 20 Micron Filtering Feature High Moisture and Acid Retention Capacity 	50	4,65 \$
DFS 033	3/8"		50	5,00 \$
DFS 052	1/4"		50	5,20 \$
DFS 053	3/8"		50	5,55 \$
DFS 083	3/8"		50	6,60 \$
DFS 084	1/2"		50	6,95 \$
DFS 163	3/8"		50	8,20 \$
DFS 164	1/2"		30	8,60 \$
DFS 165	5/8"		30	8,95 \$
DFS 304	1/2"		30	12,85 \$
DFS 305	5/8"		30	13,55 \$
DFS 306	3/4"		15	14,30 \$

CARTRIDGE DRIER

		High Moisture and Acid Trapping Suction and Discharge Filter	Pack	Price
HS-D48	Cartridge Drier		12	9,65 \$
HS-F48	Cartridge Filter		36	6,80 \$

CARTRIDGE CASES

Model No	Connection	Cartridge Drier	Specifications	Pack	Price
DFS 487S	7/8"	1	Optimum Flow Capacity High Operating Pressure Copper Welding Port 	4	49,88 \$
DFS 489S	1 1/8"			4	51,72 \$
DFS 4811S	1 3/8"			4	53,66 \$
DFS 4813S	1 5/8"			4	54,87 \$
DFS 967S	7/8"	2		4	62,25 \$
DFS 969S	1 1/8"			4	64,37 \$
DFS 9611S	1 3/8"			4	66,36 \$
DFS 9613S	1 5/8"			4	68,25 \$
DFS 14413S	1 5/8"	3		2	110,25 \$
DFS 14417S	2 1/8"			2	110,25 \$

WELDED DRIERS

Model No	Connection	Specifications	Pack	Price
DFS 032S	1/4"	Up to 20 Micron Filtering Feature High Moisture and Acid Retention Capacity	50	4,65 \$
DFS 033S	3/8"		50	5,00 \$
DFS 052S	1/4"		50	5,20 \$
DFS 053S	3/8"		50	5,55 \$
DFS 083S	3/8"		50	6,60 \$
DFS 084S	1/2"		50	6,95 \$
DFS 163S	3/8"		50	8,20 \$
DFS 164S	1/2"		30	8,60 \$
DFS 165S	5/8"		30	8,95 \$
DFS 304S	1/2"		30	12,85 \$
DFS 305S	5/8"		30	13,55 \$
DFS 306S	3/4"		15	14,30 \$
DFS 307S	7/8"		15	15,35 \$
DFS 309S	1 1/8"		15	17,15 \$



BI-DIRECTIONAL DRIERS

Model No	Connection	Specifications	Pack	Price
BFK 083S	3/8"	Heat Pump	50	12,00 \$
BFK 084S	1/2"		50	12,00 \$
BFK 163S	3/8"		50	15,00 \$
BFK 164S	1/2"		50	15,00 \$
BFK 165S	5/8"		30	15,00 \$
BFK 305S	5/8"		30	22,10 \$
BFK 306S	3/4"		30	22,10 \$
BFK 307S	7/8"		15	22,10 \$
BFK 309S	1 1/8"		15	25,35 \$



CHECK VALVES

Model No	Code No	Connection	Specifications	Pack	Price
CV-6	3601-00	1/4"		100	6,80 \$
CV-10	3601-00A	3/8"		100	8,20 \$
CV-12	3603-00A	1/2"		100	9,95 \$
CV-16	3604-00	5/8"		100	12,75 \$
CV-19	3605-00	3/4"		100	19,50 \$

Model No	Code No	Connection	Specifications	Pack	Price
CV-6T	3611-00	1/4"		100	6,80 \$
CV-10T	3612-00A	3/8"		100	8,20 \$
CV-12T	3613-00A	1/2"		100	9,95 \$
CV-16T	3614-00	5/8"		50	12,75 \$
CV-19T	3615-00	3/4"		50	19,50 \$

Model No	Code No	Connection	Specifications	Pack	Price
CVR-22T	3606-00	7/8"		30	26,70 \$
CVR-28T	3618-00	1 1/8"		16	58,50 \$
CVR-35T	3608-000	1 3/8"		16	70,45 \$
CVR-42T	3628-00	1 5/8"		16	93,50 \$

Operating pressure is 46 bar
 Operating range -40°C / +120°C

WELDED SOLENOID VALVES

Model No	Code No	Connection	Specifications	Pack	Price
EVR 3-2T	8151-00	1/4"	 -25°C / +105°C Operating Range Normally Closed Terminal Boxed Coil	40	15,52 \$
EVR 6-3T	8161-00	3/8"		40	19,90 \$
EVR 10-4T	8171-00	1/2"		40	26,70 \$
EVR 15-5T	8181-00	5/8"		24	40,60 \$
EVR 20-7T	8185-00	7/8"		10	65,65 \$
EVR 25-9T	8188-00	1 1/8"		10	81,60 \$
HVD 32-11T	8263-00A	1 3/8"		6	143,25 \$
HVD 40-13T	8265-00A	1 5/8"		4	196,95 \$
HVP 54	8201-00	2 1/8"		4	209,25 \$

- * Prices do not include the coil.
- * Operating range -40°C / +105°C













THREADED SOLENOID VALVES

Model No	Code No	Connection	Specifications	Pack	Price
EVR 3-3	8152-00A	3/8"		40	16,00 \$
EVR 6-4	8162-00A	1/2"		40	20,70 \$
EVR 10-5	8172-00A	5/8"		40	28,65 \$

- * Prices do not include the coil.
- * Operating range -40°C / +105°C

COILS

Model No	Code No	Specifications	Pack	Price
EVR 220 V AC	8010-019B-220VAC		50	13,50 \$
EVR 12 V DC	8010-019B-12VDC		50	
EVR 24 V DC	8010-019B-24VDC		50	
EVR 24 V AC	8010-019B-24VAC		50	
EVR 110 V AC	8010-019B-110VAC		50	
EVR 380 V AC	8010-019B-380VAC		50	

Code No	Model No	Specifications		Price
1518H	HIGH	Manometer 1/8" NPT High Pressure R22 - R134a - R404A and R407c Ø80 mm		8,53 \$
1518L	LOW	Manometer 1/8" NPT Low Pressure R22 - R134a - R404A and R407c Ø80 mm		8,53 \$
1527H	HIGH	Manometer 1/8" NPT High Pressure R32 - R410a Ø80 mm		8,53 \$
1527L	LOW	Manometer 1/8" NPT Low Pressure R32 - R410a Ø80 mm		8,53 \$
191H-1534	HIGH	Flanged Manometer with Glycerin 1/4" SAE High Pressure Rear Output Ø63 mm R22 - R134a R404A and R407c		14,25 \$
191L-1534	LOW	Flanged Manometer with Glycerin 1/4" SAE Low Pressure Rear Output Ø63 mm R22 - R134a - R404A and R407c		14,25 \$
HS-336-4000	90 cm / 36"	Hose Kit 90 cm 1/4" SAE		18,91 \$
HS-372-4000	180 cm / 72"	Hose Kit 180 cm 1/4" SAE		31,00 \$
HS-396-4000	250 cm / 96"	Hose Kit 250 cm 1/4" SAE		37,20 \$
1303	180 cm / 72"	Hose Kit with Ball Valve 180 cm 1/4" SAE		43,40 \$
1422	HS-T28	Copper Pipe Cutter 1/8" - 1 1/8" (3-28 mm)		17,37 \$
1423	HS-T42	Copper Pipe Cutter 1/8" - 1 5/8" (4-42mm)		32,57 \$
1430	HS-1430	Needle Extractor		24,53 \$
1222	HS-1222	Gas Flow Control Valve 1/4"		11,69 \$
1223	HS-1223	Gas Flow Control Valve 5/16"		

Code No	Model No	Specifications		Price
1071	HS-S60-104	Manifold Set Ø80 mm Manometer Protected 1/4"-5/16"150 cm Hose Kit. R410a - R404a - R407c - R134a (R410a with adapter)		84,16 \$
	HS-M01-134A	Manifold Set with Plastic Case/90 cm Hose/Car Socket/R134A		75,00 \$
	HS-M02-410A	Manifold Set with Plastic Case/90 cm Hose/R410A		65,00 \$
1024	HS-350A	Digital Manifold Set 61 Different Refr. Option - 150 cm Hose Kit.- 2 pcs. Temp. Sensor - 2 pcs. Car Char. Sock./8"		298,37 \$
1025	HS-S36F-410A	Ø80 mm Manifold Set Aluminum Body with Plastic Case 1/4"-5/16" 90 cm Hose Kit. R410a - R32		92,68 \$
1029	HS-S60-102	Manifold Set Aluminum Body 90 cm with Hose R410a - R32		74,73 \$
1132	HS-466NAH	Single Manifold High Pressure R410a - R22 - R134a - R404a		18,90 \$
1131	HS-466NAL	Single Manifold Low Pressure R410a - R22 - R134a - R404a		18,90 \$
1213	HS-MH-S	High Pressure Car Charger Socket 1/4 SAE Locked Type		19,01 \$
1214	HS-ML-S	Low Pressure Car Charger Socket 1/4 SAE Locked Type		19,01 \$
1207	HS-MH-1234	High Pressure Car Charger Socket M12 x 1,5 R1234 YF		22,58 \$
1208	HS-ML-1234	Low Pressure Car Charger Socket M12 x 1,5 R1234 YF		22,58 \$
3301-001	HS-110	1/4" Valve (with pipe) Copper Tube Length 90 mm Copper Tube Wall Thick0,6 mm		1,63 \$
14284	CT-110	1/4" Valve (without pipe)		1,16 \$
14285	HS-110-410A	1/4" Valve (without pipe) (R410A)		2,52 \$

Code	Model	Specifications	Price
101001	127	Mini Tubing Cutter 1/8"-5/8"	6,38 \$
101003	174	Big Mini Cutter 3/8"-1 1/8"	14,35 \$
101006	274	Heavy Duty Cutter 1/8"-1 1/8"	16,28 \$
101008	312	Heavy Duty Cutter 1/4"-1 5/8"	18,24 \$
101009	206	Sliding Ratchet Cutter 3/8"-2 5/8"	57,45 \$
101101	PTC-01	Capillary Pipe Cutter	7,98 \$
101201	127B	Cutting Wheel For 127 Cutter	1,75 \$
101202	174B	Cutting Wheel For 174 Cutter	1,75 \$
101203	274B	Cutting Wheel For 274 Cutter	1,85 \$
101204	312B	Cutting Wheel For 312 Cutter	1,85 \$
101205	206B	Cutting Wheel For 206 Cutter	5,75 \$
101206	170B	Cutting Wheel For 170 Cutter	7,98 \$
102003	808A	Eccentric Cone Type Flaring Tool	104,70 \$
102007	810A	Ratchet Type Flaring Tool	127,35 \$
102103	195	Heavy Duty 45° Flaring Tool In Inch Sizes	32,85 \$
102104	203	Large Size 45° Flaring Tool In Inch Sizes	57,45 \$
102105	525	Flare / Burnish Tool	35,75 \$
102161	96	All-In-1 Swaging Punch	9,58 \$
102201	275L	For 45° Flaring Tool Kit	46,92 \$
102203	278L	For 45° Flaring Tool Kit	69,25 \$
102301	100B-P	Tubing Expander Tool Set	376,65 \$
102302	100B-H	Expander Handle	118,50 \$
102303	101HT-A	Hydraulic Expander Tool	504,35 \$
102304	101HT-B	Hydraulic Expander Tool	606,50 \$
102324	100B-10	Expander Tool 5/8"	37,35 \$
102325	100B-12	Expander Tool 3/4"	37,35 \$
102326	100B-14	Expander Tool 7/8"	37,35 \$
102328	100B-18	Expander Tool 1 1/8"	68,30 \$
102330	100B-22	Expander Tool 1 3/8"	68,30 \$
102332	100B-26	Expander Tool 1 5/8"	82,95 \$
102401	404L	7 in 1 multi bender kit	179,95 \$
102441	102-04	Spring Tube Bender 1/4"	1,21 \$
102443	102-06	Spring Tube Bender 3/8"	1,72 \$
102444	102-08	Spring Tube Bender 1/2"	2,55 \$
102445	102-10	Spring Tube Bender 5/8"	3,64 \$
102446	102-12	Spring Tube Bender 3/4"	4,15 \$
102447	102-14	Spring Tube Bender 7/8"	5,43 \$
102451	364A-04	Lever Type Tube Bender 1/4"	33,20 \$
102452	364A-05	Lever Type Tube Bender 5/16"	33,20 \$
102453	364A-06	Lever Type Tube Bender 3/8"	41,82 \$
102454	364A-08	Lever Type Tube Bender 1/2"	51,35 \$
102455	364A-10	Lever Type Tube Bender 5/8"	68,63 \$
102456	364A-12	Lever Type Tube Bender 3/4"	83,63 \$
102457	364A-14	Lever Type Tube Bender 7/8"	103,10 \$



Code	Model	Specifications	Price
102501	633A	Interchangeable Torque Wrenches Complete Kit	79,16 \$
102411	GB-14161820	Gear Pipe Bender Tool Kit	2.170,48 \$
102433	368-180	3-In-1 Tube Bender	15,32 \$
102621	201	7" Pinch-Off Plier	9,58 \$
102641	900M-B	Capillary Tube With Nuts 90 cm	6,38 \$
102642	1500M-B	Capillary Tube With Nuts 150 cm	8,94 \$
102636	341	Line Piercing Valve	10,53 \$
102652	209	Inner-Outer Reamer (Metal Shell)	13,41 \$
102653	021	Hand Deburrer, Blade Can Be Swivelled	10,53 \$
102654	021B	Deburring Blade (021)	3,19 \$
102655	022	Inner-Outer Hand Deburrer	19,47 \$
102656	861-3	Hand Deburrer, Blade Can Be Swivelled	5,75 \$
102657	861-3B	Deburring Blade (861-3)	3,19 \$
102662	WSR-1251	Telescopic Inspection Mirror	8,94 \$
102682	CHV-01	Core Remove Tool For R12 & R134	3,19 \$
102684	RI-04	1/4" SAE Valve Core Remover / Installer	35,43 \$
102685	RI-05	5/16" SAE Valve Core Remover / Installer	34,80 \$
102686	RI-04 x RI-05	1/4" SAE x 5/16" SAE Valve Core Remover / Installer	34,80 \$
203074	PM-700-24	Service Manifold (Digital)	462,84 \$
202054	VC-02	Valve Core For HFC	1,44 \$
102611	122	Reversible Ratchet Wrench 1/4"-3/16", 3/8"-5/16"	6,20 \$
102613	124	Offset Ratchet Wrench 1/4"-3/16", 3/8"-5/16"	7,50 \$
102615	351	Fin Comb To Fit Sizes	6,25 \$
102616	352	Fin Comb Made Of Finest Spring-Steel	5,15 \$
300001	DP-168	Drain Pump 9.000-30.000 BTU	79,80 \$
203022	366P-3	One-Way Manifold - L.P.	31,28 \$
201031	RG2440L-80	(R22, R134A, R404A, R410A)	
201031	RG2440L-80	Single Manometer L.P.	9,90 \$
203022	366P-3	One-Way Manifold - H.P.	31,28 \$
201032	RG2440H-80	(R22, R134A, R404A, R410A)	
201032	RG2440H-80	Single Manometer H.P.	9,90 \$
202001	336RYB	90 cm Charging Hoses	25,54 \$
202002	360RYB	150 cm Charging Hoses	33,52 \$
202031	360RYB-410	150 cm Charging Hoses (R410A)	40,22 \$
202003	372RYB	180 cm Charging Hoses	39,58 \$
202004	396RYB	250 cm Charging Hoses	46,92 \$
204003	QC-L	Low Side Couplers With Adapter	22,02 \$
204004	QC-H	High Side Couplers With Adapter	22,02 \$
204005	QC-16-L	Low Side Couplers With Adapter (R1234yf)	41,18 \$
204006	QC-16-H	High Side Couplers With Adapter (R1234yf)	41,18 \$
203032	160G	2-Way Manifold with 150 cm Hose & Plastic Case	110,44 \$
203071	4WD	4-Way Manifold with Plastic Case	87,78 \$
203073	5WD	5-Way Manifold with 150 cm Hose & Plastic Case	239,40 \$



CODE	MODEL	SPECIFICATIONS							PRICE
		Flow Rate [L/H]	Press Height [m]	Suction Height [m]	db(A)	kW	Voltage	Power Consumption [kW]	
9005001000	PUMPKIN 10 	9	10	1,5	29	10	230V, 50/60 Hz	During Operation: 15 Standby: 1	€ 56,50
9006001003	EE600 	6	6	1,5	28	7,5	230V, 50/60 Hz	During Operation: 13 Standby: 1	€ 73,50
9006301015	EE1000 	10	10	1,5	27	10	230V, 50/60 Hz	During Operation: 8 Standby: 1	€ 87,75
9006301016	EE1800 	18	10	2,5	28	20	230V, 50/60 Hz	During Operation: 14 Standby: 1	€ 107,00
112893	EE1200, Duct in Ral9016 	10	10	-	27	10	230V, 50/60 Hz	During Operation: 8 Standby: 1	€ 165,00
9005401001	EE1650M (2L Tank) 	32	15	-	30	30	230V, 50/60 Hz	During Operation: 30 Standby: 2,5	€ 177,00
9005801001	EE1750M 	32	15	3	35	30	230V, 50/60 Hz	During Operation: 30 Standby: 2,5	€ 166,00
.02202	EE150 (0,2L Tank) 	120	1,5	-	29	10	230V, 50/60 Hz	During Operation: 48 Standby: 0	€ 75,80
.02210	EE300 (1L Tank) 	200	4	-	30	50	230V, 50/60 Hz	During Operation: 65 Standby: 0	€ 69,00
.02201	EE400 Neo (0,5L Tank) 	350	4	-	27	50	230V, 50/60 Hz	During Operation: 65 Standby: 1	€ 104,00
9704010010	EE900M (float switch) 	6	7	2	26	7,5	230V, 50/60 Hz	During Operation: 10 Standby: 7,5	€ 146,00
9005001002	EE200 	20	10	-	-	10	230V, 50/60 Hz	Çalışma Esnasında: 4 Standby: 1,5	€ 109,90

ECKERLE SPARE PARTS

9704010011	Temperature Sensor (EE900M)	€ 37,50
9001301008	Float Switch (EE600, EE900M, EE1000, EE1800)	€ 37,50
111261	Spare Pump and Float Switch	€ 135,50
9001301002	Float Switch (EE2000, EE1750M)	€ 37,50
9002002204	Optical-acoustic signal device for all pumps	€ 83,00

WENTO R134A DC 12-24 VOLT (LBP/MBP) COMPRESSORS

Model	Disp. CC (cm ³)	RPM	Capacity (Watt)	Oil Quan. (ml)	Voltage	Refr. Type	Price
WD 30G	3	2.000	51,6	160	12/24V DC	R134A	92,35 \$
		2.500	63,6				
		3.000	74,4				
		3.500	86,4				
WD 35G	3,5	2.000	60	160	12/24V DC	R134A	110,80 \$
		2.500	73				
		3.000	86				
		3.500	100				
WD 65G	6,5	2.000	120	160	12/24V DC	R134A	162,00 \$
		2.500	150				
		3.000	180				
		3.500	210				

* The values given in the table are given under -23.3°C / 54.4°C conditions. (Ashrae)



BAIXUE R134A DC 12-24 VOLT (LBP/MBP) COMPRESSORS

Model	Disp. CC (cm ³)	RPM	Capacity (Watt)	Oil Quan. (ml)	Voltage	Refr. Type	Price
QDZH26D	2,6	2.000	38	150	12/24V DC	R134A	92,50 \$
		2.500	48				
		3.000	58				
		3.500	68				
QDZH35D	3,5	2.000	65	150	12/24V DC	R134A	135,00 \$
		2.500	80				
		3.000	95				
		3.500	110				

- * Adjustable Battery Voltage Protection
- * Adjustable Speed Control
- * Electronic Card Heat Protection
- * Fan High Amp Protection
- * Low RPM Protection
- * Start-up Failure Protection (Too high pressure or rotor lock-up)

Model	Disp. CC (cm ³)	-23,3°C / 54,4°C			
		2000 RPM	2500 RPM	3000 RPM	3500 RPM
BD35F	2	33,1	41,3	44,9	49,7
BD50F	2,5	41,5	51,5	61,9	71,9
BD80F	3	-	67,8	78,3	89,16



FULL GAUGE CONVERTER

Model	Price
SITRAD INBOX VER.01 - MINI -PC C/SITRAD	483,05 €
CONV32 VER.03 - USD/RS485 CONVERTER	76,60 €
TCP-485 WIFI LOG VER.02 - SERIAL/ETHERNET CONVERTER	183,50 €
TCP-485 VER.04 - ETHERNET CONVERTER	138,15 €
EASYPROG VER.04 - PROGRAMMING KEY	70,10 €



FULL GAUGE CONTROL DEVICES

Model	Price
MT512E 2HP VER.13 115/230 VAC DIGITAL CONTROL DEVICE / WITH PROBE	32,75 €
TC900E LOG VER. 03 115/230 VAC DIGITAL CONTROL DEVICE / WITH PROBE	69,05 €
BC-01 CONNECTION BOX	6,00 €
MT514E VER.02 115/230 VAC C/ALARM DIGITAL CONTROL DEVICE / WITH PROBE	38,00 €
D-CORE VER.01 85-240 VAC CONTROLLER	62,75 €
RCK-602 PLUS VER.01 24VAC/DC SHELF CONTROL DEVICE	412,90 €
MT530E TEMPERATURE AND HUMIDITY SENSOR / WITH PROBE	127,90 €
MT543E 220V DIGITAL CONTROL DEVICE / WITH PROBE	76,20 €
MT543Eİ 12-24V DIGITAL CONTROL DEVICE / WITH PROBE	76,20 €
D-CORE CONTROLLER	62,75 €



VALEO VEHICLE AIR CONDITIONER COMPRESSORS

Model	Type	Voltage	Refr.	Belt Type	Disp. (cc.)	Connect.	Price
TM-13	6 Piston	12V DC	R134A	V	131	Top	208,89 €
TM-15	6 Piston	12V DC		V	147	Top	208,89 €
TM-16	6 Piston	12V DC		V	163	Top	208,89 €
TM-16	6 Piston	12V DC		T	163	Top	208,89 €
TM-16	6 Piston	24V DC		V	163	Top	208,89 €
TM-16	6 Piston	24V DC		V	163	Rear	208,89 €
TM-21	10 Piston	24V DC		V	215	Rear	341,25 €
TM-21	10 Piston	24V DC		V	215	Top	341,25 €
TM-31	10 Piston	24V DC		V	313	Top	959,33 €
TM-43	10 Piston	24V DC		V	425	Top	1.790,22 €
TM-55	14 Piston	24V DC		V	550	Top	Ask for Price
TM-65	14 Piston	24V DC		V	635	Top	

Note: Our TM-43, TM-55 and TM-65 models are the equivalent of Bitzer and Bock compressors used in bus air conditioners and are more compact, lightweight, vibration-free and efficient compressors that draw 75% less power.



Model	Specification	Price
FSF50P1	1" Flow Switch	44,00 \$

F-GAS REFRIGERANT FREON GASES

Refr. Type	Description	Kg.	Price
R134A	Freon R134A F-Gas 12 Kg. (Refillable)	12	Ask for Price
	Refillable Cylinder Tube F-Gas		
R404A	Freon R404A F-Gas 10 Kg. (Refillable)	10	Ask for Price
	Refillable Cylinder Tube F-Gas		
R407C	Freon R407C F-Gas 10 Kg. (Refillable)	10	Ask for Price
	Refillable Cylinder Tube F-Gas		
R410A	Freon R410A F-Gas 10 Kg. (Refillable)	10	Ask for Price
	Refillable Cylinder Tube F-Gas		
R32	Freon R32 F-Gas 9 Kg. (Refillable)	9	Ask for Price
	Refillable Cylinder Tube F-Gas		
R417A	Freon R417A F-Gas 10 Kg. (Refillable)	10	Ask for Price
	Refillable Cylinder Tube F-Gas		
R507	Freon R507 F-Gas 10 Kg. (Refillable)	10	Ask for Price
	Refillable Cylinder Tube F-Gas		

Refr. Type	Description	Kg.	Price
R134A	Freon 134A F-GAS 60 Kg. (Refillable)	60	Ask for Price
	F-Gas 42 Kg. / 60 Kg. Freon Cylinder Deposit		
R404A	Freon R404A F-GAS 42 Kg. (Refillable)	42	Ask for Price
	F-Gas 42 Kg. / 60 Kg. Freon Cylinder Deposit		
R407C	Freon R407C F-GAS 10 Kg. (Refillable)	54	Ask for Price
	F-Gas 42 Kg. / 60 Kg. Freon Cylinder Deposit		
R410A	Freon R410A F-GAS 10 Kg. (Refillable)	48	Ask for Price
	F-Gas 42 Kg. / 60 Kg. Freon Cylinder Deposit		



Please contact our company for your requests regarding other special refrigerant gas types.

Brand	Type	Price (1 L)	Price (4 L)	Price (20 L)
FRIGOIL	ES-32	19,00 €	70,00 €	329,00 €
FRIGOIL	ES-46	20,00 €	75,00 €	345,00 €
FRIGOIL	ES-55	22,00 €	87,00 €	388,00 €
FRIGOIL	ES-68	19,00 €	70,00 €	329,00 €
FRIGOIL	ES-170	23,00 €	87,00 €	415,00 €
FRIGOIL	ES-220	25,00 €	95,00 €	459,00 €





SIZE	90° Elbow	TE	SLEEVE	Long Elbow	45° Elbow
1/4"	Ask for Price	Ask for Price	Ask for Price	Ask for Price	Ask for Price
6 mm					
8 mm-5/16"					
3/8"					
10 mm					
1/2"					
12 mm					
16 mm					
5/8" (15,87 mm)					
3/4" (19,05 mm)					
22 mm					
7/8" (22,22 mm)					
25 mm					
28 mm					
1.1/8" (28,57 mm)					
35 mm -1.3/8"					
42 mm					
1.5/8" (41,27 mm)					
54 mm - 2.1/8"					
64 mm					
66 mm - 2.5/8"					
76 mm					
80 mm - 3.1/8"					
89 mm					
92 mm - 3.5/8"					
105 mm - 4.1/8"					
108 mm					
133 mm					
159 mm					



Oil Holder	
Size	Price
5/8"	Ask for Price
3/4"	
7/8"	
1.1/8"	
1.3/8"	
1.5/8"	
2.1/8"	



Female Tap	
Size	Price
10 mm	Ask for Price
12 mm	
15 mm	
16 mm	
19 mm	
22 mm	
25 mm	
28 mm	
35 mm - 1.3/8"	
42 mm	
54 mm - 2.1/8"	
66 mm - 2.5/8"	
76 mm	
80 mm - 3.1/8"	
89 mm - 3.1/8"	
92 mm - 3.5/8"	
105 mm - 4.1/8"	
108 mm	



Reduction					
Size	Price	Size	Price	Size	Price
10 x 8	Ask for Price	28 x 18	Ask for Price	76 x 54	Ask for Price
12 x 8		28 x 22		76 x 54	
12 x 10		35 x 15		76 x 66	
14 x 10		35 x 18		80 x 35	
14 x 12		35 x 22		80 x 54	
15 x 10		35 x 28		80 x 66	
15 x 12		42 x 15		89 x 76	
16 x 10		42 x 18		92 x 66	
16 x 12		42 x 22		92 x 80	
16 x 14		42 x 28		105 x 54	
22 x 12		42 x 35		105 x 66	
22 x 14		54 x 22		105 x 80	
22 x 15		54 x 28		105 x 92	
22 x 16		54 x 35		108 x 54	
22 x 18		54 x 42		108 x 66	
28 x 12		66 x 35		108 x 76	
28 x 14		66 x 42		108 x 89	
28 x 15		66 x 54		133 x 108	
28 x 16		76 x 42		159 x 133	

VERTICAL LIQUID TANKS

Lt	Model	D x L (mm)	Inlet & Outlet	NPT	Price
1	VLR.A.33b.01.B1.C1	89 x 205	ODS 6 - RV-1/4	-	70,00 \$
2	VLR.A.33b.02.B2.C2	120 x 215	ODS 9 - RV-3/8	-	83,00 \$
3	VLR.A.33b.03.B2.C2	140 x 235	ODS 9 - RV-3/8	-	91,00 \$
4	VLR.A.33b.04.B2.C2	140 x 305	ODS 9 - RV-3/8	-	105,00 \$
5	VLR.A.33b.05.B2.C2	160 x 300	ODS 9 - RV-3/8	-	115,00 \$
6	VLR.A.33b.06.B3.C3	160 x 350	ODS 12 - RV-1/2	-	123,00 \$
7	VLR.A.33b.07.B3.C3	160 x 410	ODS 12 - RV-1/2	-	131,00 \$
8	VLR.A.33b.08.B3.C3	180 x 380	ODS 12 - RV-1/2	-	145,00 \$
9	VLR.A.33b.09.B3.C3	180 x 410	ODS 12 - RV-1/2	-	148,00 \$
10	VLR.A.33b.10.B4.C4	180 x 460	ODS 16 - RV-5/8	-	162,00 \$
12	VLR.A.33b.12.B4.C4.F4	220 x 360	ODS 16 - RV-5/8	1/2"	195,00 \$
14	VLR.A.33b.14.B4.C4.F4	220 x 410	ODS 16 - RV-5/8	1/2"	205,00 \$
16	VLR.A.33b.16.B4.C4.F4	220 x 480	ODS 16 - RV-5/8	1/2"	230,00 \$
18	VLR.A.33b.18.B4.C4.F4	220 x 540	ODS 16 - RV-5/8	1/2"	245,00 \$
21	VLR.A.33b.21.B5.C4.F4	220 x 625	ODS 19 - RV-5/8	1/2"	260,00 \$

HORIZONTAL LIQUID TANKS

Lt	Model	D x L (mm)	Inlet & Outlet	NPT	Price
1	HLR.A.33b.01.B1.C1	89 x 190	ODS 6 - RV-1/4	-	77,00 \$
2	HLR.A.33b.02.B2.C2	120 x 200	ODS 9 - RV-3/8	-	90,00 \$
3	HLR.A.33b.03.B2.C2	140 x 220	ODS 9 - RV-3/8	-	98,00 \$
4	HLR.A.33b.04.B2.C2	140 x 290	ODS 9 - RV-3/8	-	112,00 \$
5	HLR.A.33b.05.B2.C2	160 x 290	ODS 9 - RV-3/8	-	122,00 \$
6	HLR.A.33b.06.B3.C3	160 x 340	ODS 12 - RV-1/2	-	130,00 \$
7	HLR.A.33b.07.B3.C3	160 x 400	ODS 12 - RV-1/2	-	138,00 \$
8	HLR.A.33b.08.B3.C3	180 x 370	ODS 12 - RV-1/2	-	155,00 \$
9	HLR.A.33b.09.B3.C3	180 x 400	ODS 12 - RV-1/2	-	158,00 \$
10	HLR.A.33b.10.B4.C4	180 x 450	ODS 16 - RV-5/8	-	172,00 \$
12	HLR.A.33b.12.B4.C4.F4	220 x 345	ODS 16 - RV-5/8	1/2"	205,00 \$
14	HLR.A.33b.14.B4.C4.F4	220 x 395	ODS 16 - RV-5/8	1/2"	215,00 \$
16	HLR.A.33b.16.B4.C4.F4	220 x 465	ODS 16 - RV-5/8	1/2"	240,00 \$
18	HLR.A.33b.18.B4.C4.F4	220 x 525	ODS 16 - RV-5/8	1/2"	255,00 \$
21	HLR.A.33b.21.B5.C4.F4	220 x 610	ODS 19 - RV-5/8	1/2"	270,00 \$



VERTICAL LIQUID TANKS

Lt	Model	D x L (mm)	Inlet & Outlet	NPT	Price
4	V5A.33b.04.A2.A2.F4	140 x 325	1" - 1"	1/2"	130,00 \$
5	V5A.33b.05.A2.A2.F4	140 x 395	1" - 1"	1/2"	138,00 \$
6	V5A.33b.06.A2.A2.F4	140 x 475	1" - 1"	1/2"	148,00 \$
7	V6A.33b.07.A2.A2.F4	165 x 390	1" - 1"	1/2"	160,00 \$
8	V6A.33b.08.A2.A2.F4	165 x 460	1" - 1"	1/2"	170,00 \$
9	V6A.33b.09.A2.A2.F4	165 x 510	1" - 1"	1/2"	178,00 \$
10	V6A.33b.10.A2.A2.F4	165 x 550	1" - 1"	1/2"	193,00 \$
12	V6A.33b.12.A2.A2.F4	165 x 660	1" - 1"	1/2"	209,00 \$
14	V6A.33b.14.A2.A2.F4	165 x 770	1" - 1"	1/2"	233,00 \$
16	V6A.33b.16.A2.A2.F4	165 x 870	1" - 1"	1/2"	251,00 \$
18	V7A.33b.18.A2.A2.F4	219 x 560	1" - 1"	1/2"	305,00 \$
20	V7A.33b.20.A3.A3.F4	219 x 630	1 1/4" - 1 1/4"	1/2"	329,00 \$
25	V7A.33b.25.A3.A3.F4	219 x 770	1 1/4" - 1 1/4"	1/2"	362,00 \$
30	V7A.33b.30.A3.A3.F4	219 x 910	1 1/4" - 1 1/4"	1/2"	404,00 \$
	V8A.33b.30.A3.A3.F4	273 x 585			437,00 \$
35	V7A.33b.35.A3.A3.F4	219 x 1060	1 1/4" - 1 1/4"	1/2"	451,00 \$
	V8A.33b.35.A3.A3.F4	273 x 685			470,00 \$
40	V7A.33b.40.A4.A4.F4	219 x 1210	1 3/4" - 1 3/4"	1/2"	522,00 \$
	V8A.33b.40.A4.A4.F4	273 x 785			518,00 \$
	V9A.33b.40.A4.A4.F4	324 x 560			542,00 \$
45	V8A.33b.45.A4.A4.F4	273 x 875	1 3/4" - 1 3/4"	1/2"	595,00 \$
	V9A.33b.45.A4.A4.F4	324 x 640			584,00 \$
50	V8A.33b.50.A4.A4.F4	273 x 975	1 3/4" - 1 3/4"	1/2"	632,00 \$
	V9A.33b.50.A4.A4.F4	324 x 710			622,00 \$
60	V8A.33b.60.A4.A4.F4	273 x 1165	1 3/4" - 1 3/4"	1/2"	729,00 \$
	V9A.33b.60.A4.A4.F4	324 x 850			714,00 \$
70	V8A.33b.70.A4.A4.F4	273 x 1355	1 3/4" - 1 3/4"	1/2"	816,00 \$
	V9A.33b.70.A4.A4.F4	324 x 970			804,00 \$
80	V8A.33b.80.A4.A4.F4	273 x 1545	1 3/4" - 1 3/4"	1/2"	942,00 \$
	V9A.33b.80.A4.A4.F4	324 x 1110			903,00 \$
90	V8A.33b.90.A4.A4.F4	273 x 1755	1 3/4" - 1 3/4"	1/2"	1.041,00 \$
	V9A.33b.90.A4.A4.F4	324 x 1260			970,00 \$
100	V9A.33b.100.A5.A5.F4	324 x 1410	2 1/4" - 2 1/4"	1/2"	1.104,00 \$
	V10A.33b.100.A5.A5.F4	406 x 910			1.250,00 \$
125	V9A.33b.125.A5.A5.F4	324 x 1710	2 1/4" - 2 1/4"	1/2"	1.304,00 \$
	V10A.33b.125.A5.A5.F4	406 x 1120			1.435,00 \$
150	V9A.33b.150.A5.A5.F4	324 x 2110	2 1/4" - 2 1/4"	1/2"	1.450,00 \$
	V10A.33b.150.A5.A5.F4	406 x 1340			1.595,00 \$
175	V10A.33b.175.A5.A5.F4	406 x 1560	2 1/4" - 2 1/4"	1/2"	1.780,00 \$



SUCTION LINE ACCUMULATORS

Lt	Model	D x L (mm)	Inlet & Outlet	HX (mm)	NPT	Price
1,7	SLA.33b.12.1,7	114 x 235	ODS 12 - 1/2"	-	-	76,00 \$
1,7	SLA.33b.16.1,7	114 x 235	ODS 16 - 5/8"	-	-	78,00 \$
1,7	SLA.33b.19.1,7	114 x 235	ODS 19 - 3/4"	-	-	80,00 \$
3,5	SLA.33b.22.3,5	140 x 300	ODS 22 - 7/8"	-	-	114,00 \$
5,0	SLA.33b.28.5	140 x 420	ODS 28 - 1 1/8"	-	-	140,00 \$
6,0	SLA.33b.35.6	140 x 485	ODS 35 - 1 3/8"	-	-	160,00 \$
8,1	SLA.33b.35.8,1	165 x 485	ODS 35 - 1 3/8"	-	-	182,00 \$
8,1	SLA.33b.42.8,1	165 x 490	ODS 42 - 1 5/8"	-	-	188,00 \$
9,0	SLA.33b.54.9	165 x 540	ODS 54 - 2 1/8"	-	-	226,00 \$
1,7	SLA.A.30b.12.1,7	114 x 235	ODS 12 - 1/2"	-	-	76,00 \$
1,7	SLA.A.30b.16.1,7	114 x 238	ODS 16 - 5/8"	-	-	78,00 \$
1,7	SLA.A.30b.19.1,7	114 x 242	ODS 19 - 3/4"	-	-	80,00 \$
3,5	SLA.A.30b.22.3,5	140 x 300	ODS 22 - 7/8"	-	-	114,00 \$
5,0	SLA.A.30b.28.5	140 x 425	ODS 28 - 1 1/8"	-	-	140,00 \$
6,0	SLA.A.30b.35.6	140 x 485	ODS 35 - 1 3/8"	-	-	160,00 \$
8,1	SLA.A.30b.35.8,1	168 x 480	ODS 35 - 1 3/8"	-	-	182,00 \$
8,1	SLA.A.30b.42.8,1	168 x 480	ODS 42 - 1 5/8"	-	-	188,00 \$
9,0	SLA.A.30b.54.9	168 x 530	ODS 54 - 2 1/8"	-	-	226,00 \$
13,0	SLA.A.33b.54.13	219 x 435	ODS 54 - 2 1/8"	-	-	293,00 \$
25,0	SLA.A.33b.66.25.F4	273 x 545	ODS 66 - 2 5/8"	-	1/2"	511,00 \$
32,0	SLA.A.33b.80.32.F4	324 x 520	ODS 80 - 3 1/8"	-	1/2"	670,00 \$
32,0	SLA.A.33b.92.32.F4	324 x 520	ODS 92 - 3 5/8"	-	1/2"	730,00 \$
60,0	SLA.A.33b.105.60.F4	406 x 660	ODS 105 - 4 1/8"	-	1/2"	1.370,00 \$
60,0	SLA.A.33b.109.60.F4	406 x 660	ODS 109 - 4 3/8"	-	1/2"	1.420,00 \$



& HEAT EXCHANGER

Lt	Model	D x L (mm)	Inlet & Outlet	HX (mm)	NPT	Price
3,5	SLA.E.30b.22.12.3,5	140 x 300	ODS 22 - 7/8"	ODS 12 - 1/2"	-	169,00
5,0	SLA.E.30b.28.12.5	140 x 425	ODS 28 - 1 1/8"	ODS 12 - 1/2"	-	210,00
6,0	SLA.E.30b.35.12.6	140 x 485	ODS 35 - 1 3/8"	ODS 12 - 1/2"	-	245,00
8,1	SLA.E.30b.35.12.8,1	168 x 480	ODS 35 - 1 3/8"	ODS 12 - 1/2"	-	280,00
8,1	SLA.E.30b.42.12.8,1	168 x 480	ODS 42 - 1 5/8"	ODS 12 - 1/2"	-	315,00
9,0	SLA.E.30b.54.16.9	168 x 530	ODS 54 - 2 1/8"	ODS 16 - 5/8"	-	440,00
13,0	SLA.E.30b.54.16.13	219 x 435	ODS 54 - 2 1/8"	ODS 16 - 5/8"	-	540,00
32,0	SLA.E.30b.80.22.32.F4	324 x 520	ODS 80 - 3 1/8"	ODS 22 - 7/8"	1/2"	1.000,00
32,0	SLA.E.30b.92.22.32.F4	324 x 520	ODS 92 - 2 5/8"	ODS 22 - 7/8"	1/2"	1.070,00
60,0	SLA.E.30b.105.22.60.F4	406 x 660	ODS 105 - 4 1/8"	ODS 22 - 7/8"	1/2"	1.760,00
60,0	SLA.E.30b.109.22.60.F4	406 x 660	ODS 109 - 4 3/8"	ODS 22 - 7/8"	1/2"	1.810,00



CONVENTIONAL OIL SEPARATORS

Model	D x L (mm)	Inlet & Outlet	Price
OS.33b.12.1	114 x 300	ODS 12 - 1/2"	144,00 \$
OS.33b.16.1	114 x 300	ODS 16 - 5/8"	146,00 \$
OS.33b.19.1	114 x 365	ODS 19 - 3/4"	160,00 \$
OS.33b.22.1	114 x 370	ODS 22 - 7/8"	171,00 \$
OS.33b.28.1	114 x 370	ODS 28 - 1 1/8"	174,00 \$
OS.33b.35.1	140 x 460	ODS 35 - 1 3/8"	215,00 \$
OS.33b.42.1	140 x 460	ODS 42 - 1 5/8"	230,00 \$
OS.33b.42.2	165 x 465	ODS 42 - 1 5/8"	258,00 \$
OS.33b.54.1	165 x 475	ODS 54 - 2 1/8"	268,00 \$
OS.33b.54.2	219 x 470	ODS 54 - 2 1/8"	340,00 \$



OIL FILTERS

Model	Lt	D x L (mm)	Inlet & Outlet	Sight Glass	Pressure Hole	Price
OSR.33b.01	-	50 x 125	ODS 3/8" - ODS 9	-	-	46,00 \$
OSR.33b.02	-	50 x 121	SAE 3/8" - SAE 9	-	-	47,00 \$

OIL LEVEL REGULATORS

OLR.33b.01	-	102 x 156,5	SAE 3/8" - Flange	-	-	180,00 \$
OLR.33b.02	-	102 x 156,5	SAE 3/8" - Flange	2x SW36	-	229,00 \$
OLR.33b.03	-	102 x 156,5	SAE 3/8" - Flange	1x SW36	-	188,00 \$
OLR.33b.04	-	102 x 156,5	SAE 3/8" - Flange	1x SW36	-	188,00 \$

ADJUSTABLE OIL LEVEL REGULATORS

OLR.A.33b.01	-	102 x 174,5	SAE 3/8" - Flange	-	-	196,00 \$
OLR.A.33b.02	-	102 x 174,5	SAE 3/8" - Flange	2x SW36	-	245,00 \$
OLR.A.33b.03	-	102 x 174,5	SAE 3/8" - Flange	1x SW36	-	204,00 \$
OLR.A.33b.04	-	102 x 174,5	SAE 3/8" - Flange	1x SW36	-	204,00 \$

OIL TANKS

OR.33b.04	4,0	140 x 290	RV-3/8s - RV-3/8s	2x SW36	3/8" SAE Flare	253,00 \$
OR.33b.07	7,0	160 x 400				283,00 \$
OR.33b.10	10,0	180 x 450				309,00 \$
OR.33b.16	16,0	220 x 465				373,00 \$
OR.33b.18	18,0	220 x 525				390,00 \$
OR.33b.21	21,0	220 x 610				409,00 \$



ELASTOMERIC RUBBER FOAM SHEETS 120 CM

Dynaflex - Rubber SS			
Thickness	m ² /Roll	m ² / Price (TL)	Roll / Price (TL)
3	72	68,73	4.948,81
6	36	110,10	3.963,76
9	24	147,11	3.530,56
13	16,8	211,69	3.556,44
19	12	303,50	3.641,98
25	9,6	390,24	3.746,29
32	7,2	490,86	3.534,19
40	4,8	662,49	3.179,95
50	4,8	810,60	3.890,87



ELASTOMERIC RUBBER FOAM SHEETS 120 CM

Dynaflex - Rubber SA			
Thickness	m ² /Roll	m ² / Price (TL)	Roll / Price (TL)
3	72	182,93	13.171,04
6	36	224,30	8.074,87
9	24	261,30	6.271,31
13	16,8	325,89	5.474,96
19	12	417,70	5.012,35
25	9,6	504,44	4.842,59
32	7,2	605,06	4.356,42
40	4,8	776,69	3.728,10
50	4,8	924,80	4.439,02



ELASTOMERIC RUBBER FOAM PIPES 200 CM

Dynaflex - Rubber											
Pipe Inner Diameter			Thickness								
Copper	Steel		6 mm			9 mm			13 mm		
inç	inç	Ø - mm	MT/ TL	TL/Pac.	MT/Pac.	MT/ TL	TL/Pac.	MT/Pac	MT/ TL	TL/Pac.	MT/Pac
1/4"		6	6,05	3.632,52	600	10,54	4.427,43	420	18,16	4.067,86	224
5/16"		8	7,04	3.799,62	540	11,89	3.874,71	326	19,77	4.230,96	214
3/8"	1/8"	10	7,55	3.623,95	480	13,04	3.989,43	306	21,72	3.953,60	182
1/2"		12	8,70	3.132,77	360	14,34	3.843,38	268	23,47	3.943,40	168
5/8"		15	10,18	2.911,60	286	16,51	3.434,48	208	26,07	3.962,46	152
3/4"	3/8"	18	11,54	2.884,42	250	17,15	3.156,44	184	26,77	3.533,35	132
7/8"	1/2"	22	11,95	2.509,67	210	18,46	3.101,47	168	29,40	3.057,52	104
1"		25	13,50	2.375,38	176	20,30	2.679,47	132	31,67	3.167,43	100
1 1/8"	3/4"	28	14,96	2.244,66	150	22,15	2.924,41	132	35,59	2.776,18	78
1 3/8"	1"	35	18,47	2.216,43	120	26,82	2.575,13	96	41,32	2.809,43	68
1 5/8"	1 1/4"	42	20,82	2.914,34	140	30,33	2.729,68	90	48,13	2.599,11	54
	1 1/2"	48	-	-	-	34,46	2.756,79	80	53,80	2.475,00	46
2 1/8"		54	-	-	-	38,11	3.048,53	80	58,09	2.556,08	44
2 3/8"	2"	60	-	-	-	43,22	2.333,67	54	61,92	2.724,64	44
		64	-	-	-	44,99	2.429,65	54	66,28	2.518,65	38
3"	2 1/2"	76	-	-	-	53,35	2.667,57	50	74,74	2.989,53	40
3 1/8"		80	-	-	-	55,13	2.756,44	50	79,13	2.690,50	34
3 1/2"	3"	89	-	-	-	59,60	2.860,90	48	84,88	3.055,84	36
		102	-	-	-	71,30	2.281,69	32	104,08	2.914,29	28
4 1/4"		108	-	-	-	78,15	2.500,89	32	107,90	3.021,27	28
4 1/2"	4"	114	-	-	-	80,82	2.586,21	32	112,80	2.707,10	24



ELASTOMERIC RUBBER FOAM PIPES 200 CM

Dynaflex - Rubber											
Pipe Inner Diameter			Thickness								
Copper	Steel		19 mm			25 mm			32 mm		
inç	inç	Ø - mm	MT/ TL	TL/Pac.	MT/Pac.	MT/ TL	TL/Pac.	MT/Pac.	MT/ TL	TL/Pac.	MT/Pac.
1/4"		6	-	-	-	-	-	-	-	-	-
5/16"		8	-	-	-	-	-	-	-	-	-
3/8"	1/8"	10	38,16	3.968,22	104	-	-	-	-	-	-
1/2"		12	40,51	4.050,87	100	-	-	-	-	-	-
5/8"		15	45,13	3.610,46	80	-	-	-	-	-	-
3/4"	3/8"	18	45,25	3.257,89	72	68,94	3.860,59	56	97,81	3.325,48	34
7/8"	1/2"	22	47,83	3.157,07	66	75,55	3.777,27	50	105,11	3.363,39	32
1"		25	52,36	3.141,32	60	76,50	3.978,10	52	108,91	3.049,41	28
1 1/8"	3/4"	28	55,42	3.214,42	58	81,41	3.256,39	40	117,09	2.810,25	24
1 3/8"	1"	35	63,84	3.064,35	48	95,60	2.485,72	26	123,24	2.711,17	22
1 5/8"	1 1/4"	42	72,75	2.909,81	40	107,62	2.367,63	22	142,08	2.557,43	18
	1 1/2"	48	79,79	2.393,83	30	117,19	2.343,83	20	150,51	2.709,12	18
2 1/8"		54	88,86	2.843,43	32	124,11	2.482,25	20	161,99	2.591,91	16
2 3/8"	2"	60	96,92	2.713,69	28	134,88	2.427,83	18	176,16	2.466,17	14
		64	102,17	2.656,32	26	143,91	2.590,47	18	181,73	2.544,24	14
3"	2 1/2"	76	115,03	2.760,73	24	168,58	3.034,38	18	207,93	2.910,98	14
3 1/8"		80	118,32	2.839,78	24	173,65	3.125,79	18	213,85	2.993,96	14
3 1/2"	3"	89	134,96	2.969,20	22	193,95	2.715,24	14	233,97	2.807,65	12
		102	166,46	2.996,32	18	210,62	2.948,68	14	260,34	3.124,11	12
4 1/4"		108	172,28	3.101,06	18	218,24	3.055,32	14	269,22	3.230,70	12
4 1/2"	4"	114	178,10	3.205,79	18	226,10	3.165,33	14	291,15	2.329,21	8

Dynatape Insulation Tapes			
Foam Tapes			
Product Name	TL/RL	TL/RL	TL/RL
	50 mm	75 mm	100 mm
3 MM Rubber Tape 15 MT/RL	92,59	138,89	185,19



CONVERSION TABLE

	Symbol				Conversion	
		SI	Metric	I-P		
Heat Power	P	kJ / h kW	kcal / h	Btu / h HP	1 kW = 1 kJ/s 1 kW = 860 kcal/h 1 kW = 3415 Btu/h 1 kW = 1,341 HP	1 HP = 735,5 W 1 HP = 632 kcal/h 1 Btu/h = 0,252 kcal/h 1 kcal/h = 3,97 Btu/h
Cooling				ton ref.	1 kW = 0,2843 tons of refrigeration 1 ton ref. = 3,517 kW 1 ton ref. = 3024 kcal/h	
Energy Heat	E, W, Q	kJ kWh	kcal	Btu	1 kWh = 3600 kJ 1 kWh = 860 kcal 1 kJ = 0,948 Btu 1 kcal = 3,97 Btu	1 kJ = 0,2388 kcal 1 kcal = 4,1868 kJ 1 Btu = 1,055 kJ 1 Btu = 0,252 kcal
Temp.	T	K	°C	°F	°C = (°F-32) . 5/ 9 °F= °C. 9/ 5 +32 K = 273+°C	
Volume	V	L	L	cu in cu ft gal	1 m ³ = 1000 L 1 L = 61,024 cu in 1 L = 0,2642 gal 1 m ³ = 35,315 cu ft	1 U.S. barrel = 42 U.S.gal 1 cu in = 16,3871 cm ³ 1 cu ft = 0,02831 m ³ 1 gal = 3,78541 L
Pressure	P	Pa bar mbar N / m ²	kg / cm ² kg / m ² mmSS atm	psi in H ₂ O lb / ft ₂	1 Pa = 1 N/m ² 1 bar = 100.000 Pa 1 bar = 0,987 atm 1 mbar = 10,19 mmSS 1 mmSS = 9,87 Pa 1 bar = 14,504 psi 1 mbar = 2,089 lb/ft ₂	1 mbar = 100 Pa 1 bar = 14,504 psi 1 kPa = 7,50062 mmHg 1 in H ₂ O = 249,089 Pa 1 mbar = 0,4015 in H ₂ O 1 bar = 1,02 kg/cm ² 1 lb/ft ₂ = 47,88 N/m ²
Flow	V, Q	m ³ / s	m ³ / h m ³ / s L/ s	cfm	1 m ³ /s = 3600 m ³ /h 1 m ³ /h = 0,5886 cfm 1 m ³ /h = 4,403 gal/min	1 cu ft/min = 28,3171 L/min 1 cu ft/min = 1,700 m ³ /h 1 gal/min = 0,272 m ³ /h
Length	L	m	m	in ft	1 m = 39,37 in 1 m = 3,281 ft 1 km = 0,6214 kara mili 1 km = 0,5396 deniz mili	1 in = 25,4 mm 1 ft = 30,48 cm 1 mil (kara) = 1,60934 km 1 mil (deniz) = 1,85318 km
Area	A, F	m ² m ³	m ² m ³	sq in sq ft acre	1 m ² = 1550 sq in 1 m ² = 10,764 sq ft 1 ha = 10000 m ² 1 ha = 2,471 acre	1 sq in = 645,16 mm ² 1 sq ft = 0,0929 m ² 1 acre = 0,40468 ha 1 sq mile = 2,58999 km ²
Mass	m	g kg	g kg	oz lb	1 kg = 35,274 oz 1 kg = 2,2046 lb 1 g = 15,432 grain	1 oz = 28,3495 g 1 lb = 0,4536 g 1 lb = 16 oz
Density	d	kg / m ³	kg / m ³	lb / cu ft	1 kg/m ³ = 0,06243 lb/cuft	
Velocity	w, V	m / s	m / s	ft / min	1 m/s = 196,85 ft/min 1 km/h = 0,54 Kn	1 km/h = 0,6214 mph 1 ft/min = 0,508 cm/s
Specific Heat	C, Cp	kJ / kgK	Kcal / kg °C	Btu / lb °F	1 kJ/kgK = 4,187 kcal/kg °C 1 kJ/kg0K = 0,2388 Btu/lb °F	
Heat Flow	q	kJ / m ² h W / m ²	kcal / m ² h	Btu / hft ₂	1 W/ m ² = 3,6 kJ/ m ² h 1 W/ m ² = 0,86 kcal/m ² h	1 kJ/m ² = 0,0881 Btu/ft ₂ 1 W/ m ² = 0,317 Btu/hft ₂
Heat Transfer Coefficient	K	W/ m ² K	kcal/m ² h °C	Btu/h ft ₂ °F	1 W/ m ² K = 0,1761 Btu/h ft ₂ °F 1 Btu/h ft ₂ °F = 5,678 W/m ² K 1 W/ m ² K = 0,86 kcal/m ² h °C	
Heat conduction coefficient	k	W/mK	kcal/m ² h °C	Btu/h ft F	1 W / mK = 0,578 Btu/h ft F 1 W/mK = 0,86 kcal/ mh °C	1 Btu/h ft F = 1,7296 W/mK 1 kcal/ mh °C = 1,162 W/mK
Heat Transfer Resistance	1/K	m ² K / W	m ² h °C/ kcal	h ft ² F/Btu	1 h ft ² F/Btu = 0,1761 m ² K/W 1 m ² K / W = 1,162 m ² h °C / kcal	
Heat conduction Resistance	1/k				1 mK/W = 1,7296 h ft F/BTU 1 h ft F/BTU = 0,5782 mK/W 1 mK/W = 1,162 mh °C / kcal	

Frigoduman®

FRIGODUMAN SOĞUTMA SAN. VE TİC. A.Ş.

İZMİR

2313 St. No:21 Mersinli, KONAK - İZMİR

Tel: 0 232 469 0 500 Faks: 0 232 449 7 883

İSTANBUL

İrmak St. No:75 Dolapdere, ŞİŞLİ - İSTANBUL

Tel: 0 212 237 9 777 Faks: 0 212 237 9 737